

---

Electronic Theses and Dissertations, 2004-2019

---

2010

## Film Cooling With Wake Passing Applied To An Annular Endwall

Nghia Trong Tran  
University of Central Florida

 Part of the [Engineering Commons](#)

Find similar works at: <https://stars.library.ucf.edu/etd>

University of Central Florida Libraries <http://library.ucf.edu>

This Masters Thesis (Open Access) is brought to you for free and open access by STARS. It has been accepted for inclusion in Electronic Theses and Dissertations, 2004-2019 by an authorized administrator of STARS. For more information, please contact [STARS@ucf.edu](mailto:STARS@ucf.edu).

---

### STARS Citation

Tran, Nghia Trong, "Film Cooling With Wake Passing Applied To An Annular Endwall" (2010). *Electronic Theses and Dissertations, 2004-2019*. 1687.

<https://stars.library.ucf.edu/etd/1687>



University of  
Central  
Florida



FILM COOLING WITH WAKE PASSING  
APPLIED TO AN ANNULAR ENDWALL

by

NGHIA TRONG VAN TRAN  
B.S.M.E, University of Central Florida, 2010

A thesis submitted in partial fulfillment of the requirements  
for the degree of Master of Science  
in the Department of Mechanical, Materials, and Aerospace Engineering  
in the College of Engineering and Computer Science  
at the University of Central Florida  
Orlando, Florida

Fall Term 2010

© 2010 Nghia Trong Van Tran

## ABSTRACT

Advancement in turbine technology has far reaching effects on today's society and environment. With more than 90% of electricity and 100% of commercial air transport being produced by the usage of gas turbine, any advancement in turbine technology can have an impact on fuel used, pollutants and carbon dioxide emitted to the environment.

Within the turbine engine, fully understanding film cooling is critical to reliability of a turbine engine. Film cooling is an efficient way to protect the engine surface from the extremely hot incoming gas, which is at a temperature much higher than allowable temperature of even the most advanced super alloy used in turbine. Film cooling performance is affected by many factors: geometrical factors and as well as flow conditions. In most of the film cooling literature, film effectiveness has been used as criterion to judge and/or compare between film cooling designs. Film uniformity is also a critical factor, since it determines how well the coolant spread out downstream to protect the hot-gas-path surface of a gas turbine engine.

Even after consideration of all geometrical factors and flow conditions, the film effectiveness is still affected by the stator-rotor interaction, in particular by the moving wakes produced by upstream airfoils. A complete analysis of end wall film cooling inside turbine is required to fully understand the phenomena. This full analysis is almost impossible in the academic arena. Therefore, a simplified but critical experimental rig and computational fluid model were designed to capture the effect of wake on film cooling inside an annular test section. The moving wakes are created by rotating a wheel

with 12 spokes or rods with a variable speed motor. Thus changing the motor speed will alter the wake passing frequency. This design is an advancement over most previous studies in rectangular duct, which cannot simulate wakes in an annular passage as in an engine. This rig also includes film injection that allows study of impact of moving wakes on film cooling. This wake is a simplified representation of the trailing edge created by an upstream airfoil.

An annulus with 30° pitch test section is considered in this study. This experimental rig is based on an existing flat plate film cooling (BFC) rig that has been validated in the past. Measurement of velocity profiles within the moving wake downstream from the wake generator is used to validate the CFD rotating wake model. The open literature on film cooling and past experiments performed in the laboratory validated the CFD film cooling model. With these validations completed, the full CFD model predicts the wake and film cooling interaction. Nine CFD cases were considered by varying the film cooling blowing ratio and the wake Strouhal number.

The results indicated that wakes highly enhance film cooling effectiveness near film cooling holes and degrades the film blanket downstream of the film injection, at the moment of wake passing. However, the time-averaged film cooling effectiveness is more or less the same with or without wake.

## ACKNOWLEDGMENTS

To my loving parents An Trong Tran and Muoi Van Thi. Thank you for guiding me with your wisdom and providing me with the foundations to become the person that I am today. To my sister, Thao Xuan Tran, I am grateful for your undying beliefs in me and the help you've given me.

I'd like to give special thanks to my advisor Dr. Jayanta S. Kapat for all of the knowledge and experience I've garnered through his guidance for the last four years. In addition, I'd also like to thank my committee members: Dr Jan Gou, Dr. Marcel Ilie and Dr. Son Ho, for their valuable time and support.

Dr. Son Ho, Dr. Cuong Nguyen and Dr. Mark Ricklick, I especially thank you for the guidance throughout my later college days. For my colleagues and friends Matt G., Bryan B., Tim C., An L., Abhishek S., Vaidy K., Gregg N., Michelle V. Lucky T., Josh L., Thuy N.. I thank you for the help, friendship and encouragement. Lastly, I would like to thank Siemens Energy Center for their funding the Wake-film Interaction project.

## TABLE OF CONTENTS

ABSTRACT.....	iii
ACKNOWLEDGMENTS .....	v
TABLE OF CONTENTS.....	vi
LIST OF FIGURES .....	ix
LIST OF TABLES.....	xiii
NOMENCLATURE .....	xiv
CHAPTER 1: INTRODUCTION.....	1
The History of the Turbine .....	1
Post-World War Advancements in Turbine Technology.....	2
Turbine Usage.....	4
Benefits of Efficiency Increase.....	7
Turbine Efficiency .....	8
The Limitations of the Combustor Temperature .....	10
Current Temperature Difference Solutions.....	11
Basic Film Cooling.....	12
Conflicts of Basic Film Cooling in the Turbine.....	15
Literature Review of Related Works .....	16
Overview of the Present Work.....	20

Goals and Motivation.....	20
Study Outline .....	22
CHAPTER 2: OVERVIEW OF COMPUTATIONAL STUDY .....	25
CFD Background .....	25
Mesh and Solution .....	27
Meshing Scheme.....	27
Journal File and CFD Models.....	30
CFD Package Solution Details.....	34
Verification .....	36
CHAPTER 3: OVERVIEW OF EXPERIMENTAL STUDY .....	40
Overall Assembly.....	40
Wake Generator .....	41
Blower.....	46
Test Section.....	47
Inlet Section .....	48
Black Box.....	49
Cooling Plenum .....	50
Instrumentation .....	50
CHAPTER 4: VALIDATION .....	54



Experimental Validation .....	54
Mainstream Condition .....	54
None-Moving Wake.....	55
Moving Wake.....	56
Film Cooling Validation .....	57
Experimental Validation of Wake Effect on Film Cooling .....	59
CHAPTER 5: THE EFFECT OF WAKE ON FILM COOLING PREDICTION .....	60
RANS Transient.....	60
RANS Steady .....	66
CHAPTER 6: CONCLUSIONS AND FUTURE WORK.....	68
Future Work .....	68
APPENDIX A: COMPUTER.....	70
APPENDIX B: JOURNAL FILES .....	72
Rotor .....	73
Stator Without Film Cooling .....	78
REFERENCES .....	118

## LIST OF FIGURES

Figure 1.1: Hero's Aeolipile .....	1
Figure 1.2: First British Turbo-jet Aircraft, Gloster E.28/39.....	3
Figure 1.3: Application of Gas Turbine Engines: (a) Aero-propulsion, PW2000; (b) Electrical Power Generation, GE MS5000 2E; (c) Marine Application, GE LM2500 .....	5
Figure 1.4: The Effect of Incipient Melting Temperature on Life Factor (N. D. Cardwell, 2005) .....	6
Figure 1.5: None Ideal Brayton Cycle .....	8
Figure 1.6: Film Coolnig and Metallurgy Technology Timeline (H. J. Kiesow, 2008) ...	10
Figure 1.7: Rolls Royce Rotor Cooling Scheme.....	11
Figure 1.8: Film Cooling Schematic.....	13
Figure 1.9: Vortexes from Rotor Stator Interaction (Goldstein and Eckerd, 1997) .....	16
Figure 1.10: Step by Step Flow Chart for the Study.....	22
Figure 2.1: Rotating Domain: (a) Over All View of the Domain, (b) Finer View Near Spoke Surface .....	28
Figure 2.2: Stationary Domain: (a) Over View of the Domain, (b) Fine View of all Cooling Holes, (c) Fine View of the Near Cooling Holes .....	29
Figure 2.3: Sliding Mesh.....	31
Figure 2.4: CFD Model With Two Domains: (a) Rotating Domain, (b) Stationary Domain .....	31
Figure 2.5: CFD Model Boundary Condition .....	34
Figure 2.6: Grid Independent Study.....	36

Figure 2.7: Fine Grid Convergence Index .....	37
Figure 2.8: CFD Steady Periodic .....	39
Figure 2.9: Global Mass Conservation Balance .....	39
Figure 3.1: Experimental Apparatus .....	40
Figure 3.2: (a) Fixed Surface, (b) Hub.....	42
Figure 3.3: Wake Generator Final Assembly .....	43
Figure 3.4: (a) Short Rod, (b) Long Rod .....	44
Figure 3.5: Wake Generator Wheel Assembly .....	45
Figure 3.6: Wake Generator Bearing Plate .....	45
Figure 3.7: Wake Generator.....	46
Figure 3.8: 20 HP Motor.....	47
Figure 3.9: Acrylic Test Section .....	47
Figure 3.10: Inlet Section.....	49
Figure 3.11: Black Box .....	49
Figure 3.12: Jablonski energy level diagram showing luminescence processes of a typical luminophore. ES, fluorescence; ET phosphorescence. ....	51
Figure 3.13: TSP Processes.....	52
Figure 3.14: Scani-valve and Calibration System.....	53
Figure 3.15: Correction Factor of the Scani-valve System.....	53
Figure 4.1: Span Wise Velocity Profile .....	54
Figure 4.2: Stationary Spoke Velocity Profile .....	55
Figure 4.3: Transient Wake Profile.....	57
Figure 4.4: Transient Wake Profile in Two Periods .....	57

Figure 4.5: Film cooling Validation.....	58
Figure 4.6: BR 0.5 Sr 0.1 Long Distance Validation.....	59
Figure 5.1: Temperature Contour of Case BR 1 Sr 0.1 at TS = 125 and Spoke Location = 13.2° .....	61
Figure 5.2 Temperature Contour of Case BR 1 Sr 0.1 at TS = 130, Spoke Location = 14.0° .....	61
Figure 5.3: Temperature Contour of Case BR 1 Sr 0.1 at TS = 135, Spoke Location = 14.8° .....	62
Figure 5.4: Temperature Contour of Case BR 1 Sr 0.1 at TS = 140, Spoke Location = 15.6° .....	62
Figure 5.5: Temperature Contour of Case BR 1 Sr 0.1 at TS = 145, Spoke Location = 16.4° .....	62
Figure 5.6: Temperature Contour of Case BR 1 Sr 0.1 at TS = 150, Spoke Location = 17.2° .....	63
Figure 5.7: Temperature Contour of Case BR 1 Sr 0.1 at TS = 155, Spoke Location = 18.0° .....	63
Figure 5.8: Temperature Contour of Case BR 1 Sr 0.1 at TS = 160, Spoke Location = 18.8° .....	63
Figure 5.9: Temperature Contour of Case BR 1 Sr 0.1 at TS = 165, Spoke Location = 19.6° .....	64
Figure 5.10: Temperature Contour of Case BR 1 Sr 0.1 at TS = 170, Spoke Location = 20.4° .....	64

Figure 5.11: Temperature Contour of Case BR 1 Sr 0.1 at TS = 175, Spoke Location = 21.2° .....	64
Figure 5.12: Transient RANS Centerline Effectiveness of Case BR 1 Sr 0.1 .....	65
Figure 5.13: RANS steady VS RANS Transient .....	66
Figure 5.14: Steady RANS Full Testing Matrix .....	67

## LIST OF TABLES

Table 1.1: Geometry and Flow Condition Parameter .....	23
Table 1.2: Named Scheme and Level for BR and Sr .....	24
Table 2.1: FLUENT Recommended Mesh Requirement .....	29
Table 2.2: Discretization Error for the Mesh 7 .....	38

## NOMENCLATURE

### *Roman Symbols:*

A	Area
BR	Blowing ratio, $(\rho V)_c/(\rho V)_m$
CUC	Cooling uniformity coefficient
D	Nominal hole diameter, m
DR	Density ratio, $\rho_c/\rho_m$
f	Frequency, Hz or revolution per second
FCE	Film cooling effectiveness
h	Heat transfer coefficient
K	Thermal conductivity, $W(m^{-1})(K^{-1})$
L	Length of hole center line axis, m
m	Mass flow, kg/s
MR	Momentum flux ratio
N	number of cooling holes on a test coupon
P	Pressure, Pa
p	Pitch, distance between two cooling holes, m
PR	Pressure ratio, $P_c/P_m$
R	Specific gas constant, $287 J(kg^{-1})(K^{-1})$
Sr	Strouhal number,
T	Temperature, K
V	Velocity, $m(s^{-1})$

x	Distance in the main stream direction, m
y	Distance in the theta or lateral direction, m
y <sup>+</sup>	dimensionless wall distance

*Greek symbols:*

$\alpha$	Film injection angle or inclination angle, °
$\beta$	Compound angle, °
$\eta$	FCE
$\eta$	Efficiency, example: cycle efficiency
$\gamma$	Specific heat ratio
$\rho$	Density, kg(m <sup>-3</sup> )

*Subscripts:*

a	Actual
aw	Adiabatic wall
c	Coolant
cl	Centerline
h	Hydraulic diameter
i	Inlet
m	Mainstream
r	Recovery of the mainstream
ref	Reference of mainstream
s	Static
sp	Spoke
t	Total



w Wall

*Superscripts:*

– Laterally-averaged

= Spatially-averaged

. Rate of change, [1/s]

## CHAPTER 1: INTRODUCTION

### The History of the Turbine

The purpose of a jet or turbine involves the consumption of hot fluid to power engines. Throughout history many scientists have incorporated the principle of jet to power common appliances. In as early as ancient Egypt, devices similar to the turbine have been used. One such device included the ancient turbine called an Aeolipile, see Figure 1.1. It was a simple boiler that supplied steam to two nozzles rotated on an axis. This device was the jet at its simplest form.



**Figure 1.1: Hero's Aeolipile**

Over the years, many scientists have built upon this turbine concept to power technology such as carriages and automobiles. In 1791 the first turbine was patented by

an Englishman named John Barber. However, this early turbine resembled an automotive engine (reciprocating engine) more than today's turbine engine, due to its' reciprocating compressor. This first turbine had a series of operations (intake, compression, power, and exhaust). Each operation followed the preceding one in the reciprocating engine. All actions in the reciprocating engine operated in one location of the cylinders with all of its components in constant contact. Lubricating oil is also required to keep the temperature low and decrease the friction.

In 1872, Dr. Stolze designed the first multistage turbine. The design was considered the first true turbine, since no reciprocating component was used. Unlike the reciprocating engine, the turbine engine is much more efficient due to its' high power-to-weight ratio. The turbine engine is very simple, due to few moving parts. Each component inside the turbine engine was designed to perform one process. These processes were performed simultaneously. More importantly, the turbine engine has no rubbing parts. Following Dr. Stolze, Aegidius Elling, Charles Curtis, Dr Stadford A. Moss and Dr. A. A. Griffith pursued research independently to move the gas turbine into the turbine technology that is in use today. However, even with its efficiency, due to its' massive size and cost, its' usage is limited to mostly power generation in air and sea power engines.

#### Post-World War Advancements in Turbine Technology

Despite the horrors of war, inevitably, it was the catalyst for the development of the final gas turbine engine. In order to get an advantage, many nations poured billions into

the development of an aircraft with a gas turbine jet. Out of the mix, four noticeable jet powered aircrafts were created. They include the English Whittle W1 engine, the German Heinkels HES-36 (the first true jet-propelled aircraft), the Italian Caproni-Campiri CC-2, and the American Bell XP-59.



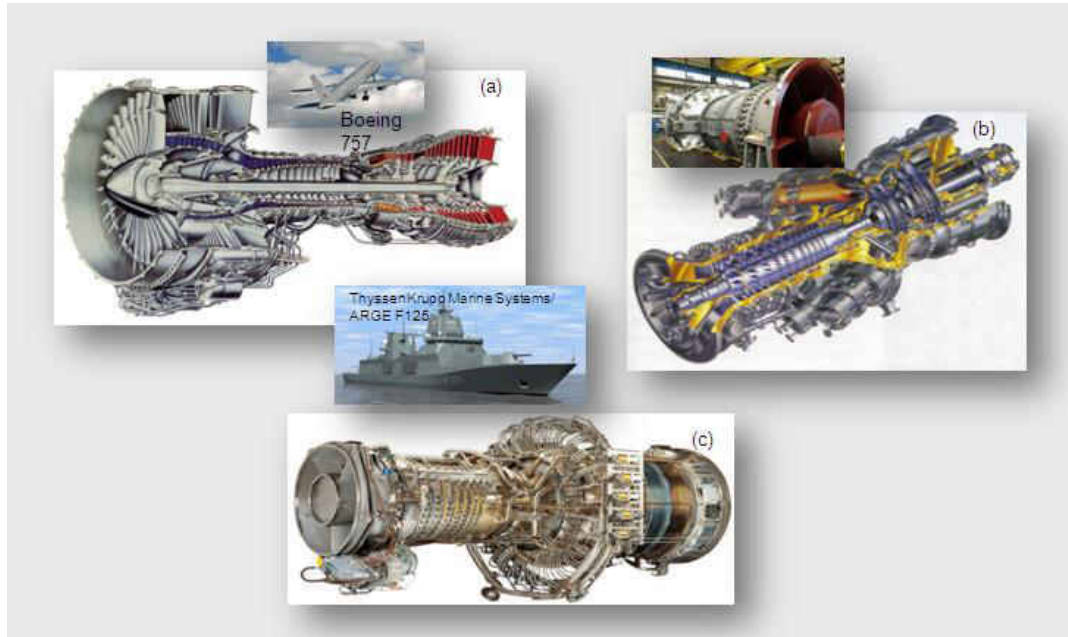
**Figure 1.2: First British Turbo-jet Aircraft, Gloster E.28/39**

At the same time, the technology developed in the wars also allowed for industrialized generation of electricity at an affordable price. In 1939, the first industrialized gas turbine power generator was designed by Aurel Stodola. Then, in 1951 the first nuclear power plant was erected in Arco, Idaho. Since the late 1940's, turbine technology has been used for air, sea and land base operation. Whether the type of turbine is gas, steam or nuclear, the turbine still follows a strict rule: the working fluid

has to be at very high pressures and temperatures to be converted into usable work. The path to that high pressure and high temperature state is dependent on the type of turbine.

### Turbine Usage

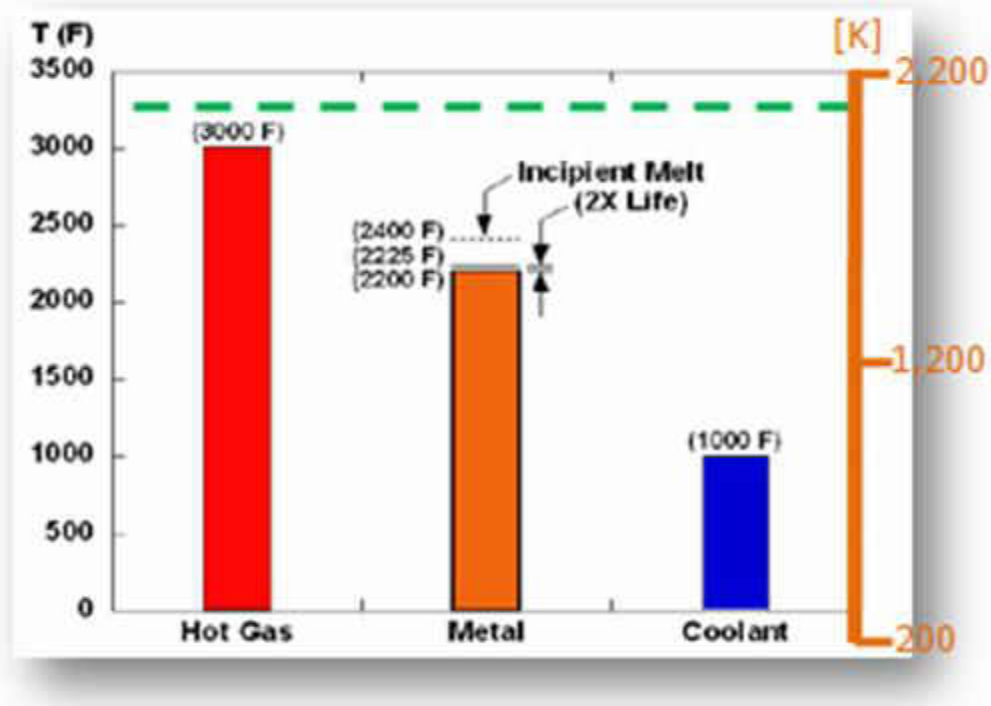
Over the years, turbine technology has had noticeable effects on air travel and electricity generation. The most standard types of turbines are gas turbines and steam turbines or a combination of the two. Nuclear power turbines are also available. These turbines are limited to only countries such as the United State, China, India, Japan, Pakistan, South Korea, and South Africa. Compared to the other types of turbines, nuclear powered turbines are one of the most efficient. In fact, 20% of the world's electricity is nuclear powered. However, it is also a hazardous way to generate power. In the past, nuclear accidents have occurred costing trillion dollars in damage and many lives. Thus, as of now, the largest source of energy for power generation is coal, at 45%. Yet, like any other fossil fuels coal is limited and the dependence on coal needs to be gradually lessened. In the quest to reduce usage of our limiting supply, research has been focused on increasing efficiency. With higher efficiency, the depletion of our coal supply can be delayed.



**Figure 1.3: Application of Gas Turbine Engines: (a) Aero-propulsion, PW2000; (b) Electrical Power Generation, GE MS5000 2E; (c) Marine Application, GE LM2500**

Air based turbines depend on different parameters when compared to land base turbines. The two main difference between land based turbines and air based turbines are the peak loads and hours of operation. A land based turbine's peak load is much lower than an air based turbine. Lower peak load means lower temperatures, even when it's running longer hours of operation. Depending on aircraft engine thrust and power generation output, the difference in temperature of the two engines can be as high as 400 degree C. This temperature difference is directly related to the differences in life expectancy of the two engines as seen in Equation 1.1. (N.D. Cardwell, 2005) did a study on the life expectancy factor based on the difference of temperatures. Cardwell concluded that the life of the metal is doubled when the contact temperature is reduced by

13° K, as showed in Figure 1.4. This experiment was utilized the maximum temperature of 1500 ° K. The value of 13° K, half life value, was very much dependent on the working fluid temperature. At a lower working fluid temperature, the half life value is higher.



**Figure 1.4: The Effect of Incipient Melting Temperature on Life Factor (N. D. Cardwell, 2005)**

$$Life_{factor} \approx 2^{\frac{\Delta T}{half\_life}} \quad (1.1)$$

Land based engines are designed to operate at the order of 50,000 hours per maintenance interval. Even though land based engines operate at much lower

temperatures, the long life requirement can lead to problems. Hot components of the turbine need to be maintained in order to prevent them from failing.

The life expectancy and efficiency are directly connected to each other through the need of cooling flow. As the input temperature increases to increase efficiency, cooling flow also needs to be increased. Given that the cooling design is constant, this can maintain or improve the lifespan. As the cooling flow (percentage of the main flow) increases, the main flow for the combustion process decreases and drags down the turbine efficiency.

#### Benefits of Efficiency Increase

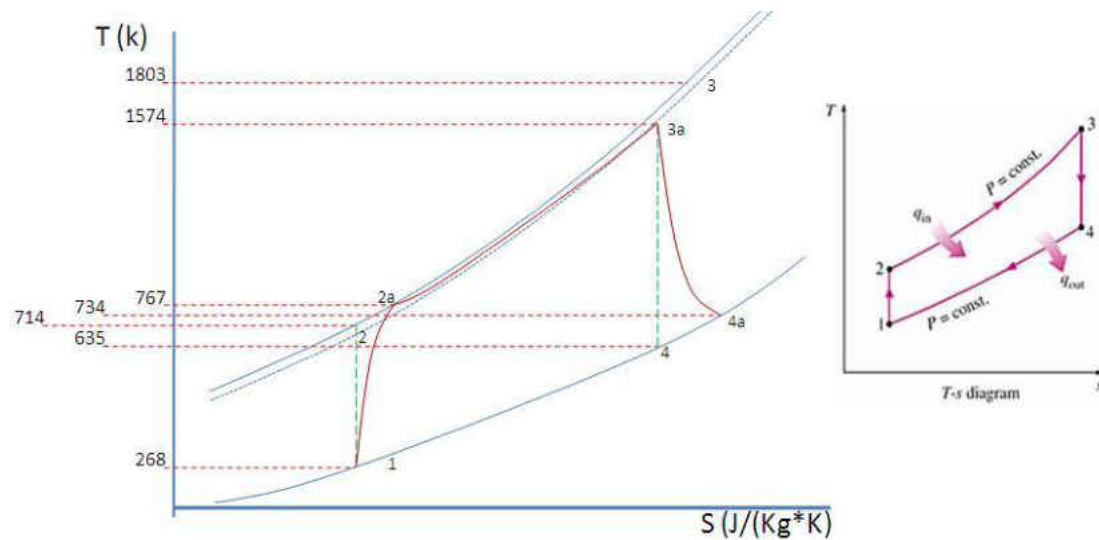
Currently, 'green' is 'in' at the moment. However, the new path of the United States is towards renewable energy. At the moment, more than 90% of all electric generation and 100% of all air transport are produced by turbines. However, a great concern in regards to this combustion process within the turbine, are the green house gas emissions produced by the turbines. Radiation, from the sun, after it has reflected from the earth's surface and ocean, gets trapped within the earth's atmosphere because it can't get pass our layer of green house gasses. In turns, the radiation heats up the earth leading to what is called the Greenhouse effect. To curtail the Greenhouse effect, less energy consumption is required. A high efficiency engine will achieve this goal. One percent or even half of a percent increase in efficiency can result in tremendous effects. Siemens Energy states that with a mere 1% increase in efficiency can provide enough extra energy



to power 1800 homes. Environmentally consciousness aside, all of this can still be boiled down to cheaper electricity prices for the consumer.

### Turbine Efficiency

To better understand the turbine engine's efficiency, the Brayton cycle is shown. The cycle provides a path of processes applied to the working fluid. The Brayton cycle is mentioned instead of the Rankine cycle because gas turbines have a wider range of usage than steam turbines. The only differences between the two models are the working fluids. The input of gas turbines is air while the input of steam turbines is water.



**Figure 1.5: None Ideal Brayton Cycle**

The T-S diagram above shows the ideal situation with four general processes: adiabatic compression, isobaric heat addition, adiabatic expansion and isobaric heat rejection. The diagram also shows the non-ideal case since ideal conditions in the environment are not realistic. However, only the ideal model will be discussed in this

research. The overall cycle efficiency,  $\eta_{cycle}$ , was used to compare between operating condition. The operating conditions of an engine, in the T-S diagram, were the pressures and temperatures of state 1, 2, 3 and 4.  $\eta_{cycle}$  is expressed in Equation 1.2 to Equation 1.3.

$$\eta_{cycle} = \frac{q_{in} - q_{out}}{q_{in}} \quad (1.2)$$

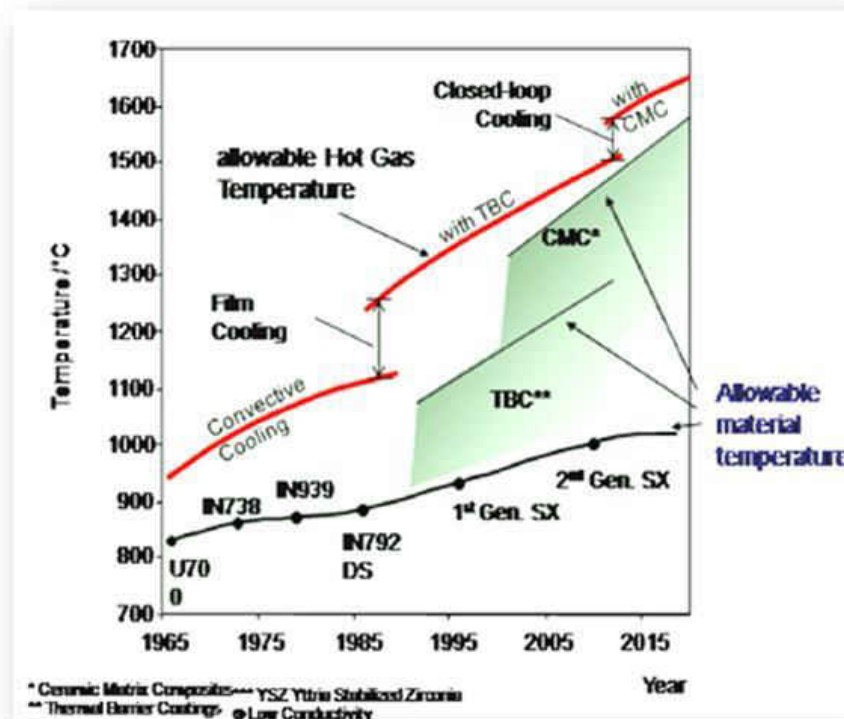
Equation 1.2 is based on the energy input and energy output of a cycle. These energy quantities are dependent on the fuel mass flow rate and fluid flow rate out of the turbine. In a more simplified version,  $\eta_{cycle}$  was expressed in terms of temperature in stage 4 and stage 3.

$$\eta_{cycle} = \eta_{ideal,Brayton} = 1 - \frac{T_4}{T_3} \quad (1.3)$$

Another analysis of engine efficiency can be seen in the area under the curve of the T-S diagram. The only way to increase this area would be to increase the pressure of state 2 and the temperature of state 4. These two parameters work hand in hand. As the pressure increases, so does the temperature. Since the pressure ratio is limited by the compressor technology, an increase the state 4 temperature is the practical solution.

### The Limitations of the Combustor Temperature

State 4 temperatures represent the combustor outlet temperature. This is the hottest area in the turbine. The current metallurgy can't keep up with this high temperature. The combustor outlet temperature is much higher than the metal's melting temperature.



**Figure 1.6: Film Cooling and Metallurgy Technology Timeline (H. J. Kiesow, 2008)**

While metal technology has increased in the past century, the difference between the combustor outlet temperature and the metal's melting temperature is still over 1000 °C. Applications of heat resistant coating such as Thermal Barrier Coating, still can't make up for the temperature difference. As a result, cracks, corrosion, fractures and material deformations is a common occurrence. In addition, a turbine engine can also

have high RPM's, ranging from 3000 to 3600 in just land base turbines. Rotors will have the added physical stress in addition to their temperature stress. Thus, the turbine industry has turned to various types of cooling to protect the hottest component of the turbine engine.

### Current Temperature Difference Solutions

The advancement in gas turbine engines has led to very high turbine inlet temperatures. As the outlet temperature of the combustor increased over the years, the cooling the first turbine stage and its' surrounding areas have become an extremely important task. Cooling methods that have been implemented include film cooling, impingement cooling, ablation, transpiration cooling, internal cooling, rib and pin fin. All cooling materials are drained from the compressor. The temperature of the compressor is also very high, around 800 °C. However, it is lower than the metal's melting point. The turbine's first stage (stator and rotor) needs the most protection from the coming hot gas.



**Figure 1.7: Rolls Royce Rotor Cooling Scheme**

The best protection for the turbine is to prevent hot gas from coming in contact with the rotor blade. Another method involves lowering the heat transfer through the blade. Heat transfer is possible due to the temperature difference in the hot gas and the cooler temperature that's outside of the main fluid path. The main purpose of most internal cooling systems is to remove heat from the local area inside the blade. Some blades in the later stage of the turbine only use internal cooling, due to lower gas temperatures. However, internal cooling will not work in the first stages, unless the heat transfer into the blade can be lowered dramatically. Therefore, external cooling or film cooling is needed.

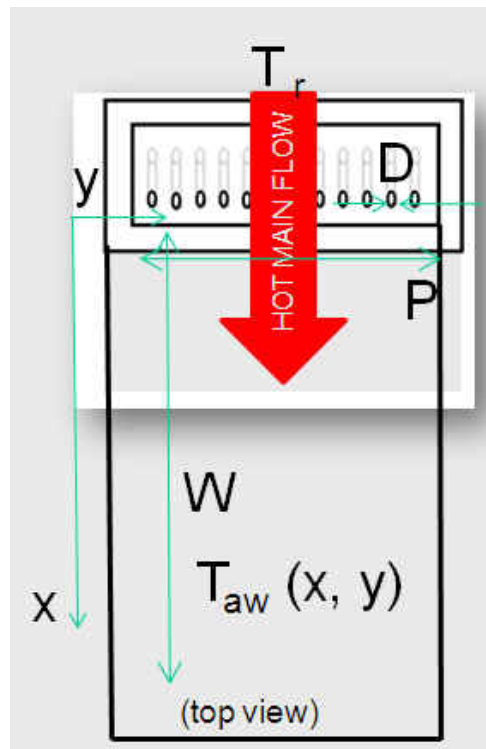
#### Basic Film Cooling

The first stage of the turbine uses cooler fluid, extracted from the compressor, for its' cooling needs. After the fluid passes through the internal passage inside the blade, it exits the blade through many angled cylindrical pathways. The figure below shows how the cooler fluid exits the out of the cylindrical pipe. The outflow of the cooler fluid, acts as a blanket separating the hot fluid from the blade's surface. The film cooling will also reduce the heat transfer rate from the hot gas to the metal.

$$q = hA(T_{ref} - T_w) \quad (1.4)$$

According to Equation 1.4, the heat transfer rate is dependent of both the surface area and the differences in temperature. If the area's heat transfer coefficient is constant,

then the heat transfer is only dependent on temperature differences. The heat blanket of the cooler film's flow will replace the hot gas' temperature as the heat source. The blanket temperature will not be as hot as the temperature from the main stream gas because the blanket is constantly replenished by the cooler film fluid. The temperature difference is now between the cooling blanket's temperature and the internal cooling temperature. It will no longer be dependent of the main stream gas' temperature and the internal cooling temperature. According to the heat transfer equation, the heat transfer rate will decrease due to a smaller difference in temperature.



**Figure 1.8: Film Cooling Schematic**

This concept also directly applies to end wall film cooling. The difference between end wall film cooling and blade film cooling is the lower temperature of the exiting cooling flow. There are no additional paths for the cooled fluid like the internal cooling passage in the blade to raise the cooling temperature. The flow goes directly from the compressor to film cooling.

Since the 1940's, research on film cooling has expanded leading to a separate field. Researchers have varied several parameters in film cooling to increase its' effectiveness level. Film cooling effectiveness,  $\eta$ , is one of several ways to compare different film cooling scheme.

$$\eta(x, y) = \frac{T_{aw}(x, y) - T_r}{T_c - T_r} \quad (1.5)$$

$$\bar{\eta}(x) = \frac{\int \eta(x, y) dy}{\int dy} \quad (1.6)$$

$$\bar{\bar{\eta}}(x) = \frac{\iint \eta(x, y) dx dy}{\iint dx dy} \quad (1.7)$$

Cooling effectiveness is the ratio of the temperature difference between the surface temperature and main stream gas temperature to the temperature difference between the exited cooling temperature and the main stream gas temperature. As the surface temperature approaches the cooling fluid's temperature, the cooling effectiveness is

increased. The goal is to have a cooling effectiveness as close to 1 as possible. Many researchers have incorporated compound angle, trench, and mask into film cooling in order to accomplish this. Different exit shape hole also show better results due to its flow diffusion property. Equation 1.5 express  $\eta$  as a local value, while Equation 1.7 and Equation 1.7 express  $\eta$  as a lateral averaged value and spatially averaged value respectively.

#### Conflicts of Basic Film Cooling in the Turbine

The flow inside the turbine is turbulent in nature due its high mach number. Rotor and stator interactions also induced wake in later stages of the turbine and different type of vortexes. However, wake interactions have only incorporated into film cooling study in as early as 1997. The periodic unsteadiness of wakes disrupts the flow. Wakes tends to reduce local velocity and increase turbulence. These two phenomenon have reversal effects. As the local velocity decreases, the film cooling effectiveness will increase near the local area of the film holes. Since the flow rate or flow velocity of the film remains the same while the main stream velocity slows down, the blowing ration of the film cooling will increase as the wake passes by the film cooling hole causing the film cooling effectiveness to increase. The increased in turbulence, on the other hand, reduces the overall goal of film cooling.





**Figure 1.9: Vortexes from Rotor Stator Interaction (Goldstein and Eckerd, 1997)**

One of the main purposes of film cooling is to reduce the heat transfer rate of the metal. As turbulence increases, the heat transfer rate will also increase. Wake can negatively affect film cooling since it leads to turbulence and disrupts flow. The wake can cause the film blanket temporary to lose its coverage and expose the surface to the hot main flow. Thus, a happy medium where wake can increase cooling effectiveness while minimally reducing the total heat transfer coefficient is needed.

#### Literature Review of Related Works

Since the invention of film cooling by Robert H. Goddard in 1929, researchers have worked to refine the technology. The first technical paper published was from J. G. V. Bohl in the 1940 (Bohl, 1940). Since then, over 2600 articles have been published in film cooling research worldwide (Kercher, 2003). Over the years, several noticeable parameters most applicable to basic film cooling have been discussed. They were

inclinational angle, hole-length to diameter ratio, blowing ratio, density ratio and pitch to diameter ratio. Inclinational angle,  $\alpha$ , is defined as the angle between the cylindrical hole and the main stream surface. Hole-length to diameter ratio,  $l/D$ , is defined as the length of the cylindrical hole divided by the cooling hole diameter. Blowing ratio, BR, is defined as the product ratio of the velocity and density between the hot gas and cooling fluid. Density ratio, DR, is defined as the ratio of the hot gas density to the cooler fluid density. Pitch to diameter ratio,  $p/D$ , is the ratio of the pitch between cooling hole to the cooling hole diameter.

In 1968, a study by R. J. Goldstein (Goldstein et al, 1968) varied the parameter of ' $\alpha$ ' between 35 degrees and 90 degrees. The parameter BR was also varied between 0.1 and 2. The parameter  $l/D$ , DR,  $p/D$  was constant at 43, 1, and 3 respectively. In this experiment, it was actually film warming, instead of film cooling that was used over the flat plate. Film warming is the usage of hotter fluids to separate the surface from the cooler main stream. Film warming is normally used in research. The result from film warming is identical to that of film cooling. In both cases  $\eta$  behaves differently at different  $\alpha$  and BR. With 35 degree  $\alpha$ ,  $\eta$  is constant, as long as Br is under 0.75. With the same  $\alpha$ ,  $\eta$  increases as BR increases over 0.75. When  $\alpha$  is at 90 degree,  $\eta$  behaves in reverse but at the BR of 1.0. The BR of 0.5 gives the maximum  $\eta$ . It should be noted that the result is at discrete location. At this time,  $\eta$  cannot be concluded as the function of only  $\alpha$  and BR.

The parameter BR was again studied by Eriksen (Eriksen et al, 1974). Parameters  $\alpha$ , DR and p/D were constant at 35, 1 and 3 respectively. BR was varied from 0.3 to 2.0. This was done to a single hole and a row of cylindrical holes. It was concluded that  $\eta$  is a strong function of BR. At the lower BR of 0.3 to 1,  $\eta$  slightly decreased. When BR is above 1,  $\eta$  increases more dramatically. Later studies showed that high BR can also cause jet lift off and mix into the main stream. This results in the loss of film blanket and a lower  $\eta$ .

The parameter DR and BR were also studied by Sinha (Sinha et al, 1991). DR was varied between 1.2 and 2, while BR was varied between 0.3 and 1. This was done to a single hole of film cooling and a whole row of film cooling. Other parameters  $\alpha$ , l/D and p/D were constant at 35, 18 and 3 respectively. The main reason for this study was to analyze the effects of momentum ratio to film cooling. Momentum ratio is a function of both BR and DR. Since momentum ratio is not studied in this thesis, it will only be mention here. The momentum ratio factor determined the lift off and re-attachment of film cooling jet. The results concluded that  $\eta$  decreased significantly as DR decreased due to loss of film cooling spreading.

In 1992, a study was done on the physical attributes of the film cooling jet. Hasis found a vortex inside the film cooling jet which was named the Kidney vortex (Nguyen, 2010). This Kidney vortex promoted hot gas ingestion and film cooling lift off. This effect heightens at high BR. In 2009, Haven and Kurosaka have also studied the physical attributes of the shape film cooling. In this study, an anti Kidney vortex was discovered.

The anti Kidney vortex spreads the Kidney vortex apart. The anti Kidney also nullifies the lift off affect of the Kidney vortex. This ability helps the shape film cooling jet re-attach to the surface much easier.

(Nguyen et al, 2009) did a parametric study on all important basic film cooling parameter. The parameters that were included in this study were  $\alpha$ ,  $l/D$ ,  $p/D$ , BR and DR. This study mentioned the most optimal parameters from past film cooling studies. These optimal values were used as the base case. The optimized  $p/D$  was 2.78 (Dorrington et al, 2007).

(Freidrichs, 1997) did a study of film cooling on a flat end wall. This study was the first to incorporate film cooling inside airfoil cascade. This was also the first research of the 3-D aerodynamic effects on film cooling. Freidrichs concluded that the secondary flow and the coolant jet greatly affected the distribution of film cooling.

From 1998 to 2004, five noticeable studies were done on the effects of turbulence on film cooling: (Varadarajan et al, 2004), (Bons et al, 1994), (Kohli et al 1998), (Ekkad et al, 1997), (Burd et al, 1998). The results of these studies concluded negative effects of the main stream turbulence's effects on film cooling. Turbulence tends to increase mixing between the main flow and film cooling flow. The cooling blanket will disperse and decrease its effectiveness. In some cases, especially at high BR, the main flow turbulence also helped the coolant re-attach to the surface.

In the late 90's, several research studied the effects of wake on film cooling in a rectangular cascade. (Funazaki et al, 1997), (Funazaki et al, 1998) studied the effect of

wake on film cooling on a blunt body, similar to the blade's leading edge. The result is similar to that of the turbulence effects.  $H$  was reduced at low BR. At higher BR, the effect of the wake was nullified. Here, film cooling re-attachment was not mentioned.

### Overview of the Present Work

#### Goals and Motivation

The ultimate goal of this study is to understand the physical interactions between the wake and film cooling inside an annulus section. Currently, there are many studies focused on the full interactions between film cooling, rotors and stators. These studies are aimed at the secondary flow and the vortexes generated from these interactions. However, in order to design a better film cooling scheme, understanding the effects of wake on film cooling at different locations on the blade is even more important. In this study, the focus was on the effects of wake on film cooling in an annulus test section. Several papers, like (Womack et al, 2009), have studied the effects of film cooling in a rectangular test section. However, this study will incorporate the annulus factor to simulate conditions most similar to the inside of the turbine. In addition, this study will address the little amount of information on the physical attributions of film cooling with passing wake. The computational fluid dynamic model in this study will show the wake's effects on the film jet and the cooling blanket. The results will allow more insight into why film cooling's effectiveness increases or decreases. Furthermore, the CFD model will show the wake's effects on certain areas of the film cooling jet.

To accomplish this goal, only the basic film cooling structures will be used inside the test section. To eliminate variables and complications, the experiment will employ

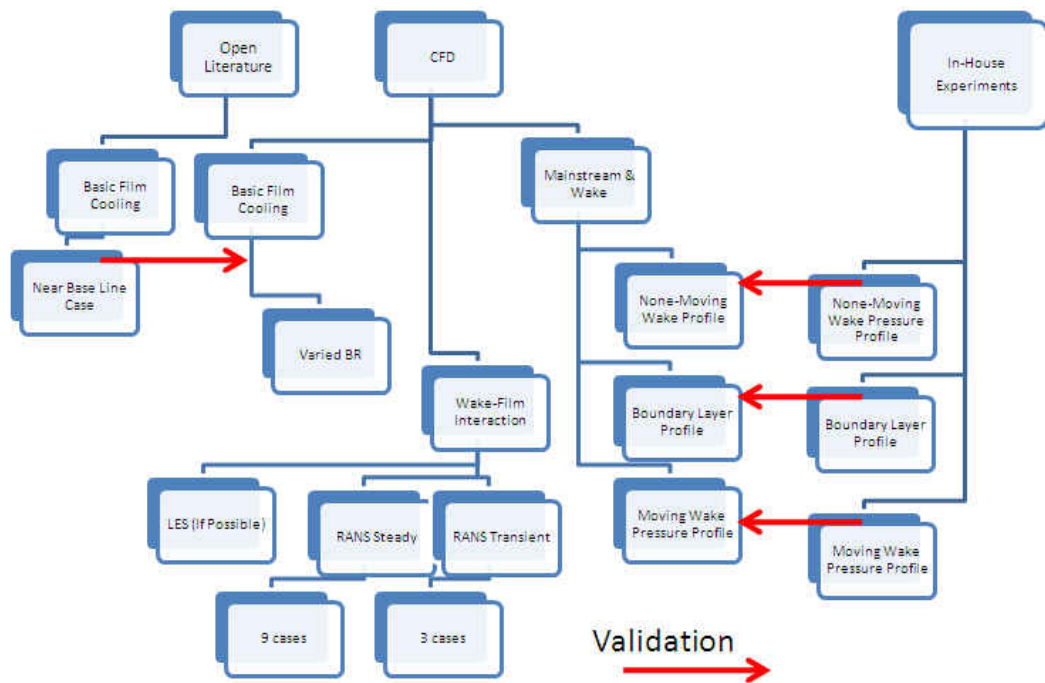
the value of film cooling parameters that is considered to give the maximum cooling effectiveness. The focused parameters will be BR and  $Sr_s$ . BR is the blowing ration between the main cooling and the main flow. Sr is the Strouhal number, a dimensionless number used to describe the strength of the wake. The Strouhal number is expressed in Equation 1.8.

$$Sr = \frac{2\pi f L_{h,sp}}{V_m} \quad (1.8)$$

Film cooling effectiveness is a very strong function of BR. The effect of the wake is a strong function of Sr. In this study, spoke diameter was used to calculate Sr. In many other studies, the value of film cooling diameter was used to calculate  $Sr_c$ . The only difference between the two Sr values is the ratio of the spoke diameter and film cooling diameter. BR is varied between 0.25, 0.5, 1.0 and 2.0. This will allow for the observation of cooling deficiency as well as the lift off effects of the film cooling. As for Sr, there are 3 major views on the range it should be for engine conditions. (Heidmann et al, 2001) states that the typical engine condition is ranged from 0.15 to 0.6 for Sr. (Han, 1993) observed a wider range of Sr: 0.15 to 1.6 in his experiment. (Funazaki et al, 1998) only varied the Sr from 0.2 to 0.4. Thus, this study will only use the Sr, 0.1 and 0.3. The base line will be the BR of 1 at zero wake or the  $Sr = 0$ .

## Study Outline

This study will be divided into two brackets: experimental works and CFD, as shown in Figure 1.10. The main works of this study was based on CFD with the support of past research and in-house experiments. CFD results will also be validated by past research and in-house experiments. The observations of the wake-film interactions will be validated by CFD works. The CFD model will also be verified by the grid independent study and mass balance. The grid independent study will assure that the CFD model's mesh is adequate to provide data and small enough to operate with limited resources.



**Figure 1.10: Step by Step Flow Chart for the Study**

The CFD's boundary conditions were set to the experimental rig's condition. The CFD model was designed to replicate the experimental rig. Any variations between the

experimental rig and the CFD model was verified to ensure that it wouldn't have any effects on the final results.

The RANS model will also be used to help in analysis of the results. Past research has shown that the standard  $k-\omega$  numerical viscous model (SKW) may over-predict the diffusion of jets which would explain the high effectiveness value at higher  $x/D$ . For this reason, the RKE model was used as a turbulence viscous model for predictions of film cooling effectiveness for the current numerical study of the sensitivity design. The LES model will also be attempted if possible.

**Table 1.1: Geometry and Flow Condition Parameter**

<u>Parameters</u>	<u>Value</u>
Diameter, $D$ [m]	.002
$l/D$ [dimensionless]	13
$p/D$ [dimensionless]	3
Inclination angle, $\alpha$ [°]	35
Blowing ratio, $BR$	0.5,1.0,2.0
Density ratio, $DR$	1
Strouhal number, $Sr$	0,0.3,0.4
Mainstream temperature, $T_m$ [K]	300
Cool-stream temperature, $T_c$ [K]	340
Mainstream total pressure, $P_{t,i}$ [Pa]	101.325
Mainstream pressure, $P_{s,i}$ [Pa]	101,275

Table 1.1 shows all the parameter value within this study. Any variation is also shown in the table 1.1. Table 1.2 will define the 9 cases that were run in the steady



RANS model. Transient RANS will also apply to the 3 cases with the best BR. The transient RANS will show the complete physical attribution of the wake-film interaction.

**Table 1.2: Named Scheme and Level for BR and Sr**

<u>Varied Parameter</u>	Sr = 0	Sr = 0.1	Sr = 0.3
BR = 0.5	BR 0.5 Sr 0	BR 0.5 Sr 0.1	BR 0.5 Sr 0.3
BR = 1.0	BR 1 Sr 0	BR 1 Sr 0.1	BR 1 Sr 0.3
BR = 2.0	BR 2 Sr 0	BR 2 Sr 0.1	BR 2 Sr 0.3

## CHAPTER 2: OVERVIEW OF COMPUTATIONAL STUDY

### CFD Background

In the 1960's, the first computational fluid dynamic, CFD, code of its kind emerged as Panel Code A230. With the emergent of new computer technology, computational fluid dynamic has growth into a three dimensional problem. Either a simple two dimensional problem or a complicated three dimensional problem, the basics of all CFD are stemmed from the Navier-Stoke's equations, which are Newton's second law applied to fluids. Navier-Stoke's equations are nonlinear partial differential equations in its original form. With its nonlinear property, it is impossible to solve the convective acceleration component of the equation. In order to bypass this problem, there are many forms of the Navier-Stokes equations or simplified versions of the equations that can be applied to today's computer technology. To reinstate, as good as today's technology is, the computational resources needed to solve an instantaneous and exact Navier-Stokes equation for a certain fluid model is still out of reach.

$$\rho \left( \frac{\partial V}{\partial t} + V \cdot \nabla V \right) = -\nabla p + \mu \nabla^2 V + \left( \frac{1}{3} \mu + \mu^v \right) \nabla (\nabla \cdot V) + f \quad (2.1)$$

$$\rho \left( \frac{\partial V}{\partial t} + V \cdot \nabla V \right) = -\nabla p + \mu \nabla^2 V + f \quad (2.2)$$

The fundamentals of all CFD are to break the given fluid model into smaller pieces of volume, to apply a fitting Navier-Stoke's equation to each of the smaller volumes, and to solve for all unknowns simultaneously. This procedure can be a daunting task for any human being, but for a computer this is quite common. Like a curve, the discretization is fully depended on the number of steps and the size of each step. In a CFD model, the solution is dependent on the number of smaller volumes and the size of the smaller volumes. These smaller volumes form volume meshes or a grid. In a CFD study, the quality of the mesh depends on several factors: the skewness, the aspect ratio, and the  $y^+$  value. The importance of these values will be discussed in the next section. For now, the higher the numbers of cells in a mesh or the smaller the numbers of volume inside the fluid model, the more accurate the solution will become.

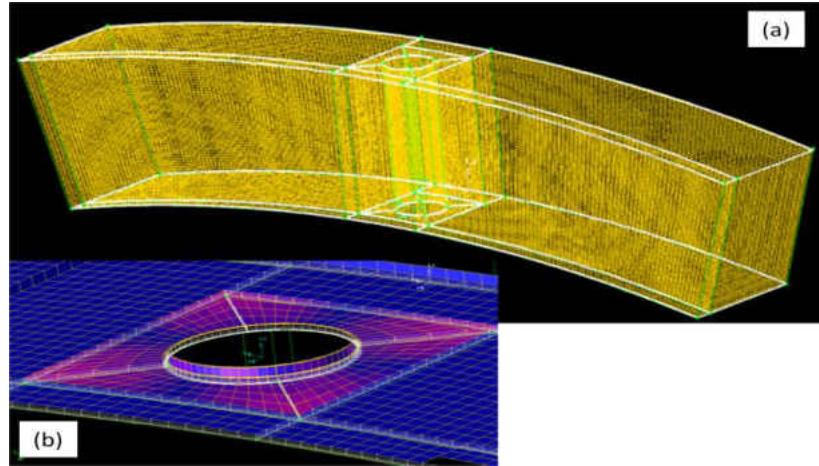
Many turbulent algorithms like RANS and LES are used to predict the flow behaviors. These predictions vary in accuracy and cost effectiveness. In order to eliminate of the turbulent algorithms altogether, the number of cells in the fluid model must be high enough to make the grid's size or the cell's size small enough to resolve the turbulent component of the Navier-Stoke's equation. In order to be considered small enough, it has to be on the Kolmogorov microscales or on the smallest dissipative scales of the eddies (turbulent is formed from eddies and is ranged from the smallest Kolmogorov microscales to the intergral scale. The integral scale is depended on the boundary layer thickness). The time scale in the problem must also satisfy the Kolmogorov microscales. When the spatial and temporal scale is satisfied, it is called

direct numerical simulation (DNS). The number of cells needed for DNS is in the cube power of Reynolds number. For a transitional flow inside a tube with Reynold's number of 2300, the mesh has to be in the order of  $12E9$

### Mesh and Solution

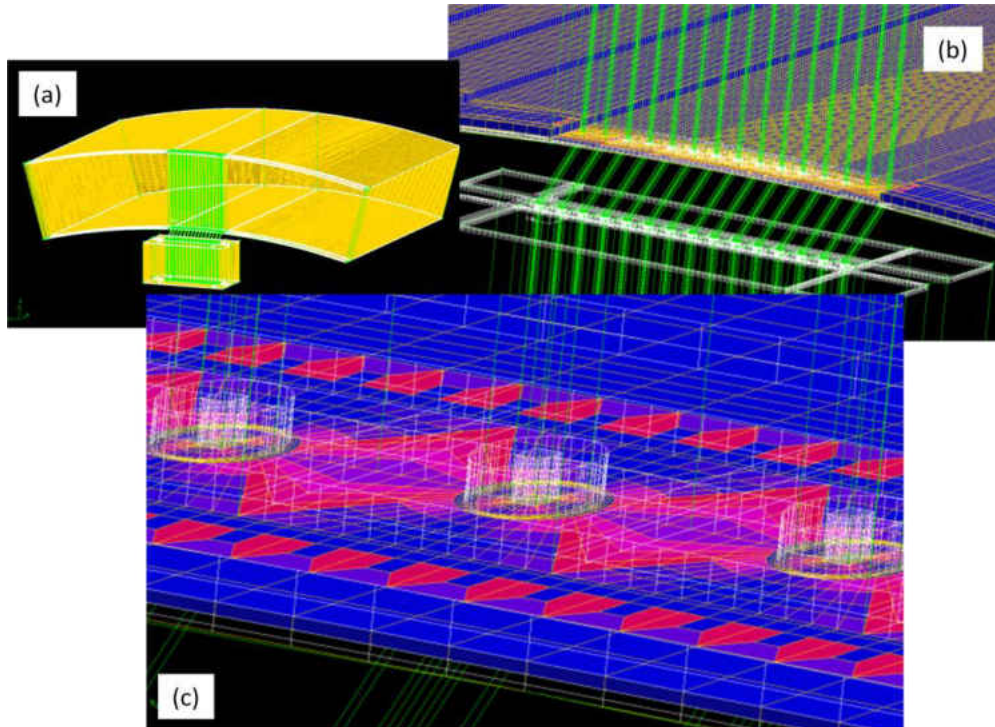
#### Meshing Scheme

The mesh in this study was generated by GAMBIT software (v2.4.6). The idea behind the mesh is controls and isolation. In today's meshing software, user's friendliness ideology has become computer resources dependent. This style of meshing does not result in more accurate solution but a waste of time and resources. In GAMBIT or some of the better software, the user can isolate the different regions for different grid sizes. Desired regions will require finer mesh, which will give better results. The region outside of the desired zone has a coarser mesh. Controlled and isolated meshing will also assure the quality of the mesh. As said before, the quality of the mesh is dependent on the skewness, the aspect ratio, and the  $y^+$  value.



**Figure 2.1: Rotating Domain: (a) Over All View of the Domain, (b) Finer View Near Spoke Surface**

In today mesh, the most common topology is hexahedron. The ideal mesh must maintain the skewness of 0 (cell's angle of  $90^\circ$ ) and the aspect ratio of 1 in all cells. In a more practical world, the skewness is kept under 0.7 (scale from 0 to 1) and the aspect ratio is kept under 40 (range from 0 to infinity). A controlled and isolated meshing will assure the most complicated shape to achieve this quality. For the mesh with film cooling holes, the idea is to isolate the cylinder from the rest of the model. Inside this isolation region, the circle shape can be divided in a way for the computer to map the quadrilateral shape as a replacement. This will assure the skewness and aspect ratio is maintained at acceptable value.



**Figure 2.2: Stationary Domain: (a) Over View of the Domain, (b) Fine View of all Cooling Holes, (c) Fine View of the Near Cooling Holes**

$$y^+ \equiv \frac{u_* y}{\nu} \quad (2.3)$$

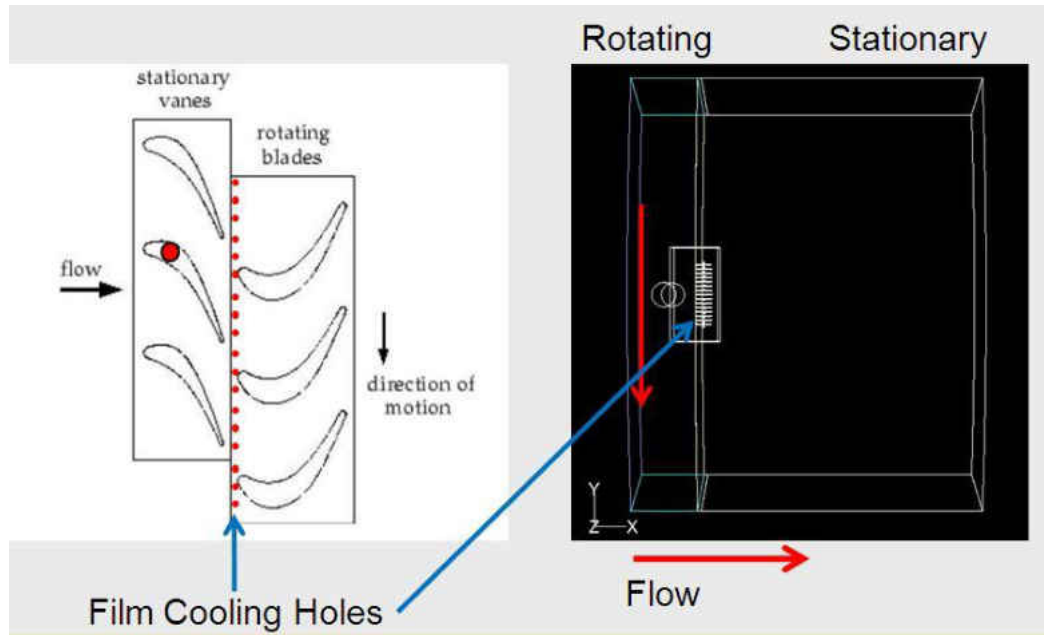
**Table 2.1: FLUENT Recommended Mesh Requirement**

<u>CFD Wall Application</u>	<u>Y<sup>+</sup></u>	<u>Description</u>
Enhance Wall Treatment (EWT)	$Y_p^+ \approx 1$ , Can go up to $Y_p^+ \leq 5$ First cell in Laminar Sub layer	Low Re flows, better drag, Pressure-drop prediction
Standard Wall Functions (SWF)	$Y_p^+ \geq 30 - 300$ First cell in Log Layer	High Re flows, little gain by resolving sub layer
Non-Equilibrium Wall Functions	Limits same as SWF, Account for delta P effect	For mildly separating, reattaching flows

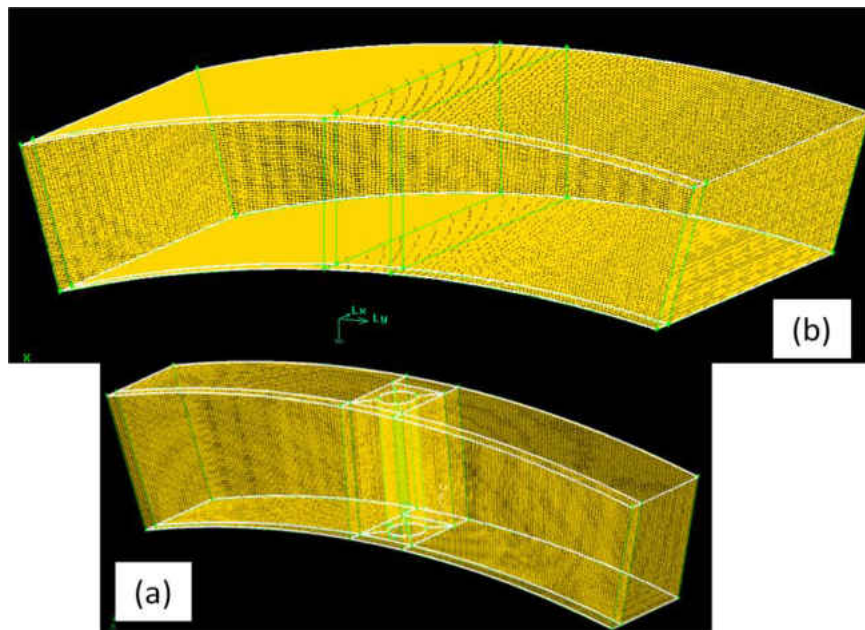
The last factor,  $y^+$ , is important for fluid interaction with any type of wall. The parameter  $y^+$  can be expressed in equation 2.3, where  $u^*$  is the friction velocity,  $y$  is the distance between the cell's center and the wall, and  $\nu$  is the kinematic viscosity of fluid. The  $y^+$  value is applied to the first cell in the laminar sub-layer. The recommended  $y^+$  value for Enhanced Wall Treatment is from 1 to 5 (Fluent documentation, v6.3). The CFD model in this study is meshed with the  $y^+$  value below 2 for all wall location.  $y^+$  value is recommended by FLUENT documentation. The highest skewness value is 7.1 and the highest aspect ratio is 50 (still acceptable). These values will assure accurate convergent in the model, given that the correct boundary conditions are applied.

#### Journal File and CFD Models

A journal file is generated by GAMBIT to provide a more express re-meshing. A meshing each individual model is very time intensive. With the journal file, all commands can be easily read by GAMBIT and can be carried out in the matter of minutes. Journal file allows the usage of varying cell dimensions. This technique is a great way to alter the meshing domains: the number of cells and the  $y^+$  value. This method is very useful for the grid independent study. Due to the complexity of the study, there are two different CFD models: “wake without film cooling” and “wake with film cooling”.



**Figure 2.3: Sliding Mesh**



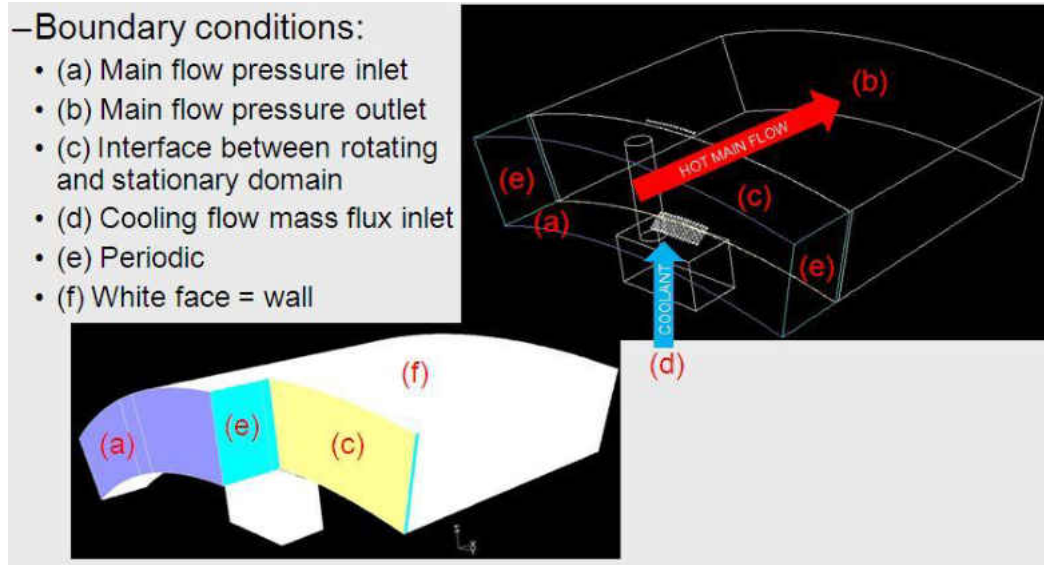
**Figure 2.4: CFD Model With Two Domains: (a) Rotating Domain, (b) Stationary Domain**



The “wake without film cooling” model has two domains: Figure 2.5a, rotating domain, and Figure 2.5b, stationary domain. The domains are named for its rotating property and non rotating property respectively, not the actual rotor and stator blade. The rotating and stationary domains are its own mesh. The CFD package, (FLUENT, v12.1), combined the two domains, completing the model. The principal idea behind FLUENT is sliding mesh, Figure 2.4. When building two completely different domains, the dimensions between the two domains must be kept in tack. The exit face of the rotating domain and the inlet face of the stationary domain occupied the same space. These two faces are renamed “rotor interface” and “stator interface”. The sliding mesh model allows the two face to move at two different speeds. The inlet of the rotor domain is set to boundary condition type pressure inlet. The total pressure is set at atmospheric pressure with a set static pressure that resulting in 16 m/s inlet velocity. The outlet of the stator domain is set to boundary condition type pressure outlet. The static pressure of the outlet boundary condition is set to the same static pressure of the inlet boundary condition. The operating condition of the model is 0 kPa, therefore all pressure values are absolute. The stator and rotor domains’ top and bottom are named stator shroud, stator hub, and rotor shroud and rotor hub respectively. The stator shrouds and hubs are set to stationary wall. The stator domain’s two side walls are also set to stationary wall. The stationary domain models the experimental test section to every detail. The rotor’s two side wall is set to rotating periodic boundary. The rotating periodic boundary condition is used because the rotor domain of the CFD is modeled after the wake

generator of the experimental rig. The wake generator is the 360° or full rotating wheel. Since a 30° section of the wake generator is modeled, two flow perpendicular faces are set as rotating periodic condition. The spoke cylinder, and rotor shroud and hub are set as moving wall with zero relative speed. The rest of the face inside the model is set as interior, especially any faces around the spoke that was used to control and to isolate the meshing scheme.

The “wake without film cooling model” is used for the grid independent study and experimental validation. With the help of the journal file, the “wake without film cooling” model is produced with 8 different mesh sizes for the grid independent study, ranging from 25,000 cells to 3.5 million cells. The “wake without film cooling” run at different Sr number, matching the experimental rig, for validation. The “wake with film cooling” has two purposes: validation by the open literature on basic film cooling and CFD prediction of wake on film cooling. The spoke of the rotating domain can be set at any angle relative to the stationary domain. To validate the basic film cooling, the spoke is set to the nearest side wall with no rotational speed. With negligible effect wake, the film cooling section can be validated by open literature.



**Figure 2.5: CFD Model Boundary Condition**

#### CFD Package Solution Details

As stated in earlier section, DNS is not possible in the current state of technology. While LES is obtainable, due to time constrain, only RANS solution model will be used for this study. More specifically, this study employed Realizable  $\kappa$ - $\epsilon$  model with enhanced wall treatment. The Realizable  $\kappa$ - $\epsilon$  model is the newest Navier-Stokes algorithm. (FLUENT, v12.1) states that Realizable  $\kappa$ - $\epsilon$  model contains the new formulation for the turbulent viscosity and that  $\epsilon$  was derived from an exact equation for the transport of the mean square vorticity fluctuation. Realizable  $\kappa$ - $\epsilon$  model has strong effects on film cooling due to the accurate predictions of the spreading rate of both planar and round jets. This model is also likely to provide superior performances for flows involving rotation, boundary layers under strong adverse pressure gradients, separation, and recirculation.

The model transport equations for  $\kappa$  and  $\epsilon$  in the Realizable  $\kappa$ - $\epsilon$  are:

$$\frac{\partial}{\partial t}(\rho\kappa) + \frac{\partial}{\partial x_j}(\rho\kappa u_j) = \frac{\partial}{\partial x_j} \left[ \left( \mu + \frac{\mu_t}{\sigma_\kappa} \right) \frac{\sigma\kappa}{\partial x_j} \right] + G_\kappa + G_b - \rho\epsilon - Y_M + S_\kappa \quad (2.4)$$

and

$$\frac{\partial}{\partial t}(\rho\epsilon) + \frac{\partial}{\partial x_j}(\rho\epsilon u_j) = \frac{\partial}{\partial x_j} \left[ \left( \mu + \frac{\mu_t}{\sigma_\epsilon} \right) \frac{\sigma\epsilon}{\partial x_j} \right] + \rho C_1 S_\epsilon - \rho C_2 \frac{\epsilon^2}{\kappa + \sqrt{\nu\epsilon}} + C_{1\epsilon} \frac{\epsilon}{\kappa} C_{3\epsilon} G_B + S_\epsilon \quad (2.5)$$

where,

$$C_1 = \max \left[ 0.43, \frac{\eta}{\eta + 5} \right] \quad (2.6)$$

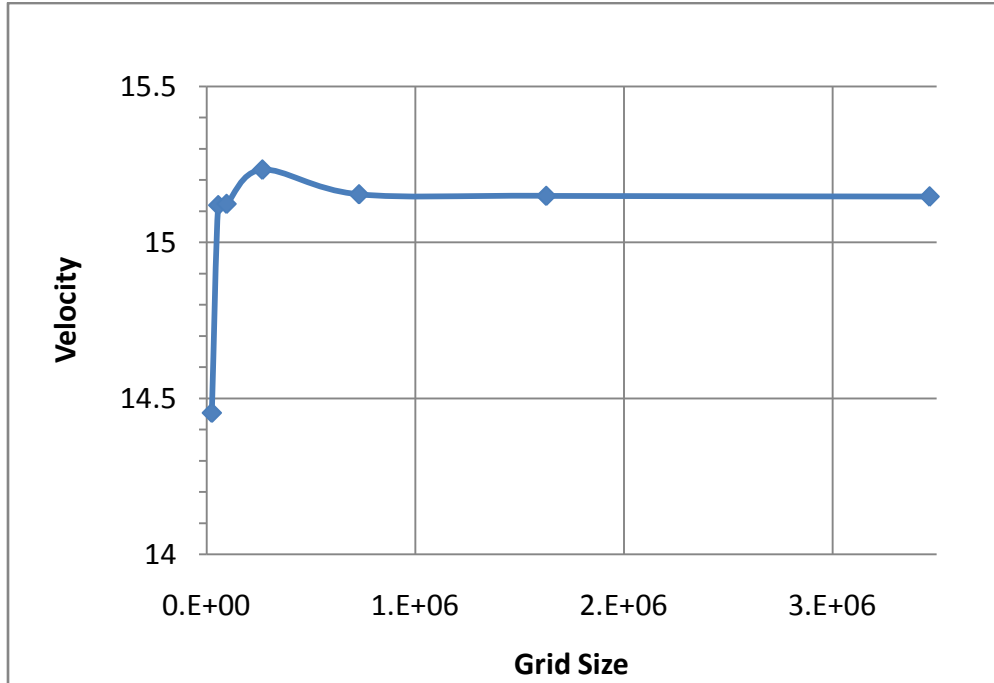
$$\eta = S \frac{\kappa}{\epsilon} \quad (2.7)$$

$$S = \sqrt{2S_{ij}S_{ij}} \quad (2.8)$$

The rest of the coefficients are set as default by FLUENT package

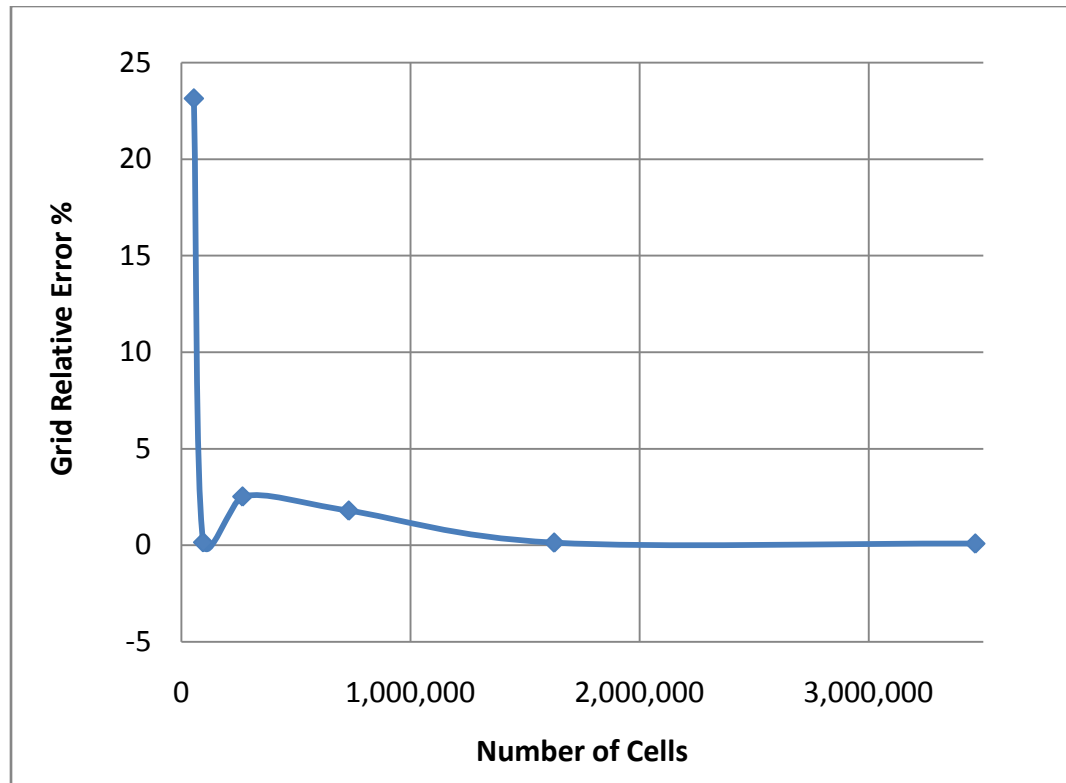
## Verification

### *Grid Independence Study*



**Figure 2.6: Grid Independent Study**

Grid independent study was carried out to minimize the computer resource that is needed in obtaining an accurate solution. There are 7 different grid size meshes, ranging from: 25,000 cells to 3.5 million cells. The extract solution from the 7 meshes is compared to the mesh size. According to Figure 2.7, grid number 5, of 730,000 cells, is fine enough to deliver accurate solution. Any size larger than 730,000 is not needed and will be a waste of computer resource for RANS calculation.



**Figure 2.7: Fine Grid Convergence Index**

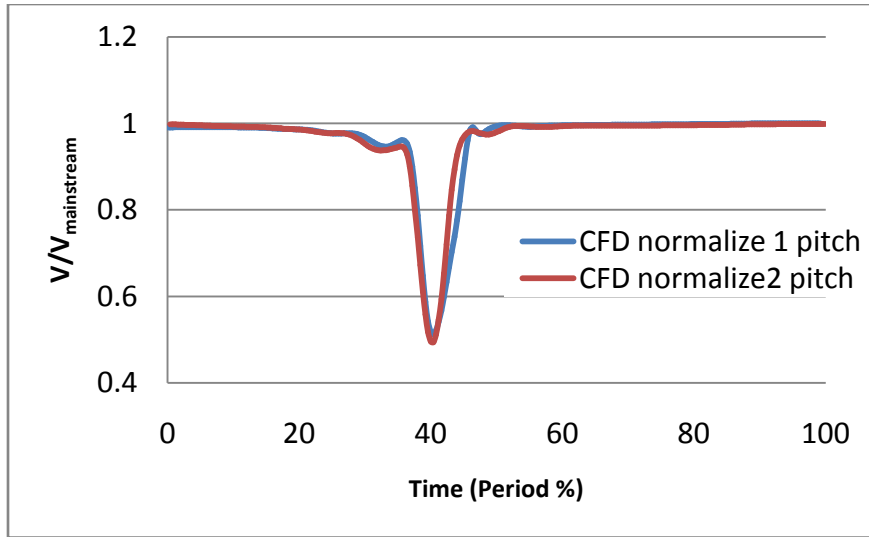
Furthermore, with the recommendation of the Journal of Fluids Engineering Editorial Policy, procedure for estimation and reporting of uncertainty due to discretization in CFD application was carried out in this study (Celick, 1993). The procedure for estimation of discretization error was carried out exactly as described in the procedure. At 730,000 cells, the solution's approximate error is 1.5%. The numerical uncertainty in the find-grid solution for the extracted data is 1.5 %. The fine grid convergence index or GCI is 1.6%.

**Table 2.2: Discretization Error for the Mesh 7**

$\Phi = \text{interface BC local velocity}$	
N5, N6, N7	0.7E6; 1.6E6; 3.4E6
R65	1.3
R76	1.28
$\Phi 5$	15.1545
$\Phi 6$	15.1497
$\Phi 7$	15.1468
P	0.066
$\Phi 21_{\text{ext}}$	15.1602
E21_approximate	0.02%
E21_relative	0.09%
GCI21_fine	0.08%

### *Steady Periodic*

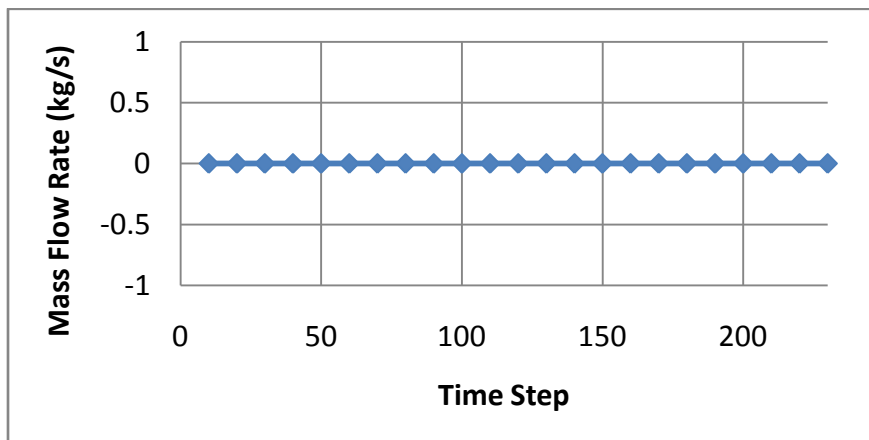
To verify the CFD model produce steady periodic result, two period of wake passing was produced. Figure 2.9 shows CFD model produce nearly constant results with time. The reason that two curve is not perfectly on top of each other is due to the transient property of the solution.



**Figure 2.8: CFD Steady Periodic**

*Mass Balance*

Mass balance of the entire model is also kept in each case. All in flows and out flows are sum up at each interval for reporting. The figure below shows that the model satisfies the conservation of mass law.

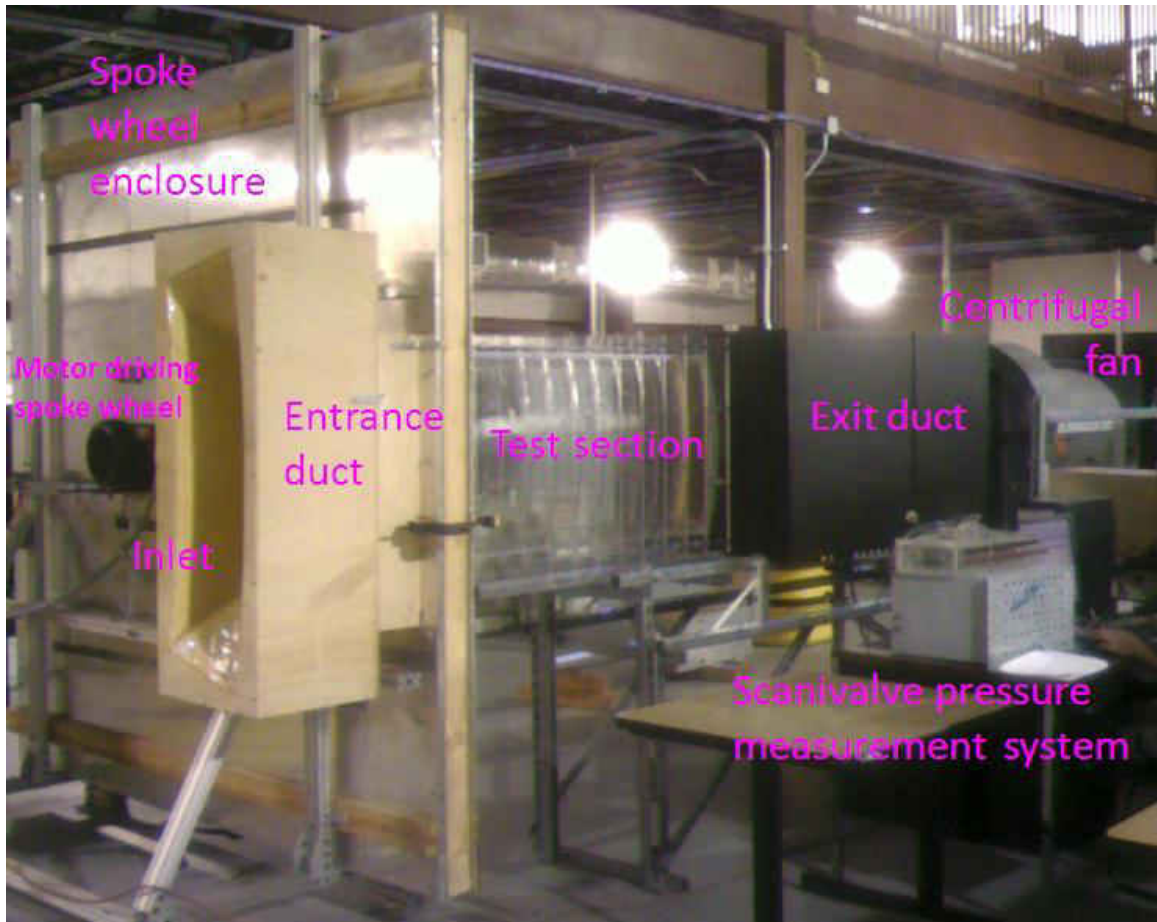


**Figure 2.9: Global Mass Conservation Balance**



## CHAPTER 3: OVERVIEW OF EXPERIMENTAL STUDY

### Overall Assembly



**Figure 3.1: Experimental Apparatus**

Ambient air is driven by suction through a bell-mouth nozzle with a area ratio of 2.5:1 to the test section. The fluid passes through the wake generator before enters the test section. The wake generator is driven by a 3.73 kW motor with variable frequency

drive. The variable speed drive controls the variation in Strouhal number. The RPM of the wheel is measured by stroboscope and chronometer.

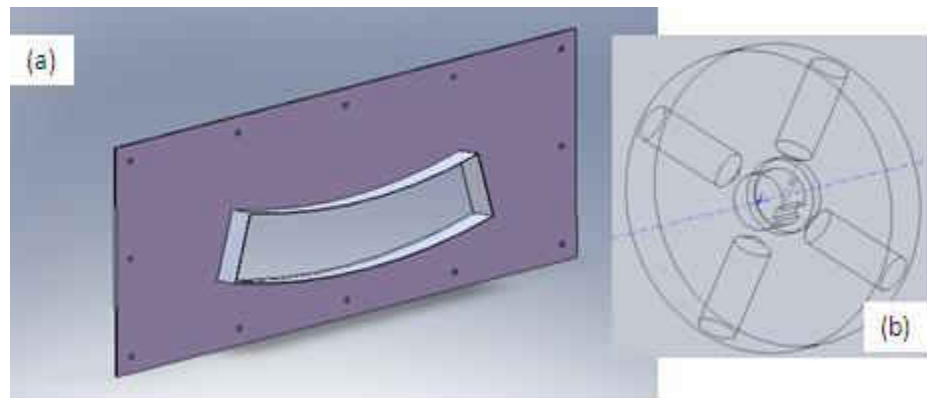
The mainstream is maintained at room temperature. No flow conditioning is used due to the relatively low turbulence associated with entry in an open loop tunnel. In addition, rigid rubber flaps were used on the wake generator ID and OD to mitigate shedding and prevent a secondary flow from forming in the wake generator casing due to rotation. Boundary layer thickness and momentum thickness were  $10D$  and  $1.5D$ , respectively, at the location of coolant injection.

#### Wake Generator

The wake generator is a simulation of the rotor-stator interaction. It is powered by a 5 HP motor with a variable speed drive. It can effectively vary the rotational speed from 0 to 300 RPM. It was designed with interchangeable spoke diameter. It was designed specifically to fit an annulus test section with an ID and OD of 39 inches and 44 inches respectively. The rotating assembly is enclosed by a wooden box with aluminum cover. The aluminum cover prohibits any air leakage through the wood. The supporting frame is made from 4020 Aluminum. The wake generator is also an interface between the inlet and the test section, all have identical cross section. The cross section is constant throughout the test section.

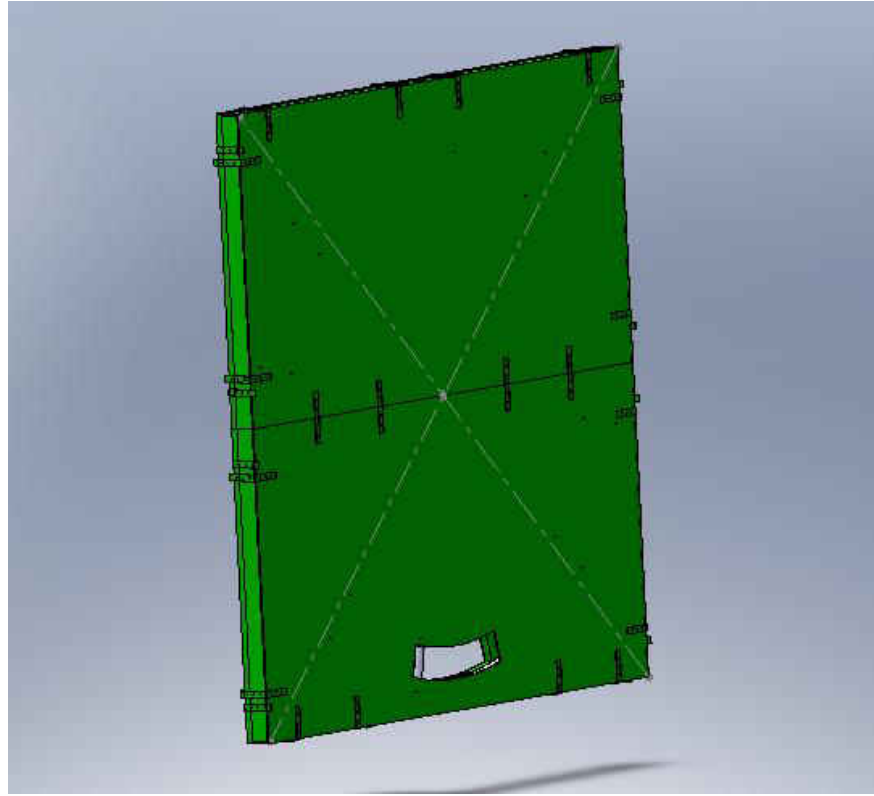
The wood housing of the wake generator was built in three separate parts. The First part was built as the bottom part of the housing. This was consisted of two  $4' \times 8' \times 1'$  square blocks and eight  $2.875'' \times 4'' \times 1/4''$  square pieces. Next, these pieces were put

together multiple times to form a shoebox shape without the top. These parts were joined together by L-brackets and mating brackets. The top part of the housing was built the same way as the bottom part of the housing, except for the dimensions of the plate is now  $\frac{1}{4}'' \times 4' \times 8'$ . The last part of the housing section was the Cascade part or fixed surface. This was done to limit the amount of flow that will go into the housing and kept the flow in region of interest. This can be seen in the Figure 3.2a.



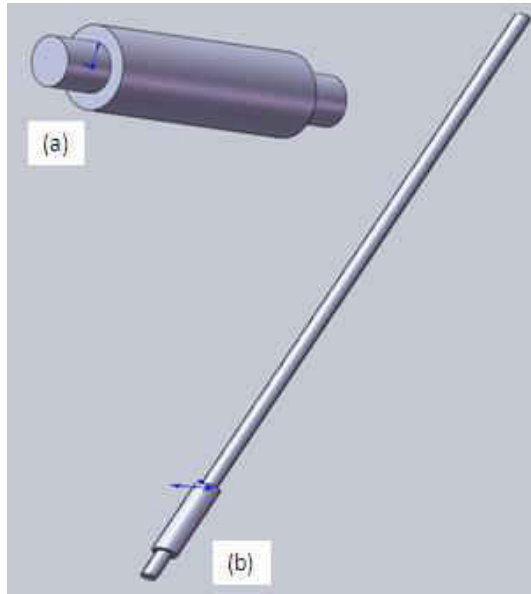
**Figure 3.2: (a) Fixed Surface, (b) Hub**

These parts were designed and modified a few times to produce the optimal design. The final assembly can be seen in Figure 3.3. The third assembly is the wheel assembly. The wheel assembly is consisted of many parts and precise accuracy. The first designed part was the hub which will hold the rods or spokes and inner and outer rings of the wheel. Figure 3.2b shows the hub with a radius of 3 inches and a thickness of 1 inch.



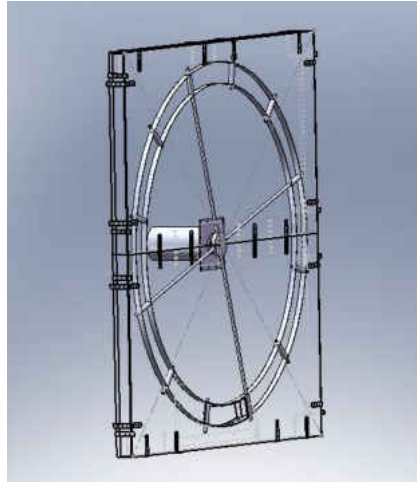
**Figure 3.3: Wake Generator Final Assembly**

The next part is the spoke or rod, which mimics a rotator in a turbine engine. The rod was divided into two parts: short rod and long rod. The short rod has the dimensions of 7.35 inches long with a 0.375 inch radius tips with a length of 1.125 inches and 0.625 inch radius base with a length of 5.10 inch. This will be place in between the inner and outer rings. The short rod has two purposes: holds the inner and outer wheel in place and be a cylinder to create wake. The long rod is a longer version of the short rod. The inner metal piece of the long rod is threaded at the end and bolted into the hub. This can be seen in the Figure 3.4b.



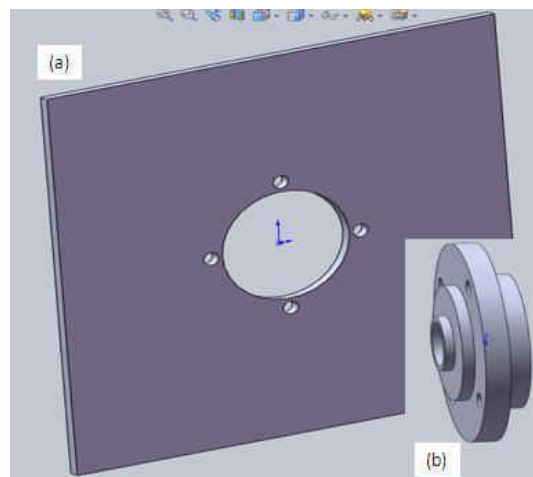
**Figure 3.4: (a) Short Rod, (b) Long Rod**

The wheel assembly is consisted of the outer and inner. Two individual parts were created. The outer and inner rings have the diameters of 86.26 inches and 76.38 inches respectively. The thickness and width for both rings are 0.25 inches and 1 inch respectively. Each rings has 12 pre drilled 0.375 inches radius holes with an offset of 30 degree angle.  $\frac{3}{4}$  inches hex head nut was used to secure the end of each rod. The next step was to assemble all parts together to create a fan shaped mechanism. All parts are made of galvanized aluminum. Such assembly can be seen in Figure 3.5.



**Figure 3.5: Wake Generator Wheel Assembly**

The shaft nut secures the shaft to the hub and the shaft collar. The shaft collar can be thickening to extend the shaft making the required distance between the motor and inside housing surface. The next part is the wall bearing or the plate. The plate is used to attach the bearing to the housing.



**Figure 3.6: Wake Generator Bearing Plate**



**Figure 3.7: Wake Generator**

#### Blower

A 20 HP motor powers the blower. The electrical system was set up by certified electrician. The blower was set up to provide the rig with the negative pressure. The maximum velocity at the inlet of the experimental rig is 16 m/s. The inlet velocity is used as the main stream velocity. The set cooling plenum pressure and BR are calculated from the mainstream velocity. The blower is on a frame and was set to be level with the test section, the wake generator interface and the rig inlet. The motor is covered by a metal case for protection.



**Figure 3.8: 20 HP Motor**

Test Section



**Figure 3.9: Acrylic Test Section**



The test section is made of acrylic. The cross section is a 30° annulus with ID and OD of 39 inches and 44 inches respectively. The test section is made up of 4 surfaces: ID surface, OD surface and two SIDE surfaces. The ID and OD surfaces slide into the two SIDE surfaces. The 4 surfaces form the test section with two open ends. Acrylic welder is used to glue the 4 surfaces together. The inlet matches up with the wake generator. The outlet matches up with the black box (described in later section). The ribs are used to hold the test section together. All ribs have the same cross section. Furthermore, the ribs are enforced by 4 long rods. The rods make sure the ribs do not move from their position. The acrylic is transparent so temperature data can be measured using the emissive property.

#### Inlet Section

The inlet section is placed before the wake generator. The beginning of the inlet section is scaled 2.5 times larger than the test section cross section. The inlet section is made up of foam, which is placed within a wooden box. The inlet and the outlet wooden surface are precut with the two cross sections. The foam is carved with foam cutter. Wood filler and carbon fiber are then used to coat on the foam.



**Figure 3.10: Inlet Section**

Black Box



**Figure 3.11: Black Box**

Two black boxes connect the test section to the blower. The test section's cross section has an annular shape. The blower inlet is a circle. The two black boxes are made up of foam like that of the inlet section. The inside of the boxes are carved by foam

cutter. The foam cutter forms a smooth surface to connect two different cross sections. The two black boxes allow the blower to suck in the air without disrupting the velocity profile of the test section.

### Cooling Plenum

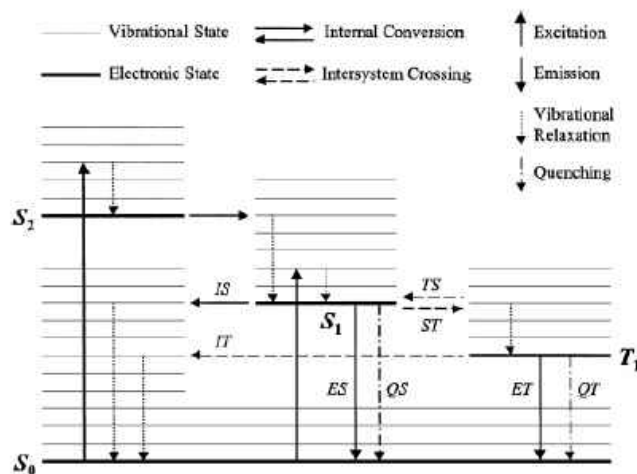
The secondary flow was supplied by a compressed air supply regulated to the required pressure. This flow was passed through an inline heater and into the plenum after passing through a pressure regulator to adjust the blowing ratio. The film cooling coupon was made using rapid prototyping with an ABS plastic. The coupon surface was made to match the radius of the inner diameter of the duct. There were 19 film cooling holes with an inclination angle of 35 degrees, parallel with mainstream flow, and diameter of 2 mm. The pitch to diameter ratio and the length to diameter ratio were 3 and 13 respectively. The injection location was located 15.2 cm ( $5 D_s$ ) downstream of the wake generator. To reduce the conduction error for the adiabatic wall measurements, the inner diameter surface of the plenum module was made of a polycarbonate substrate with high density Rohacell foam which has a thermal conductivity of 0.029 W/mK.

### Instrumentation

#### *Temperature Sensitive Paint Technique*

Temperature sensitive paint technique or TSP is the process to capture the temperature contour of the test section's surface. Temperature sensitive paint used in this study is manufactured by ISSI Inc. TSP liquid is made by dissolving luminescent florescent molecules with a transparent polymer in a solvent. The desired surface is

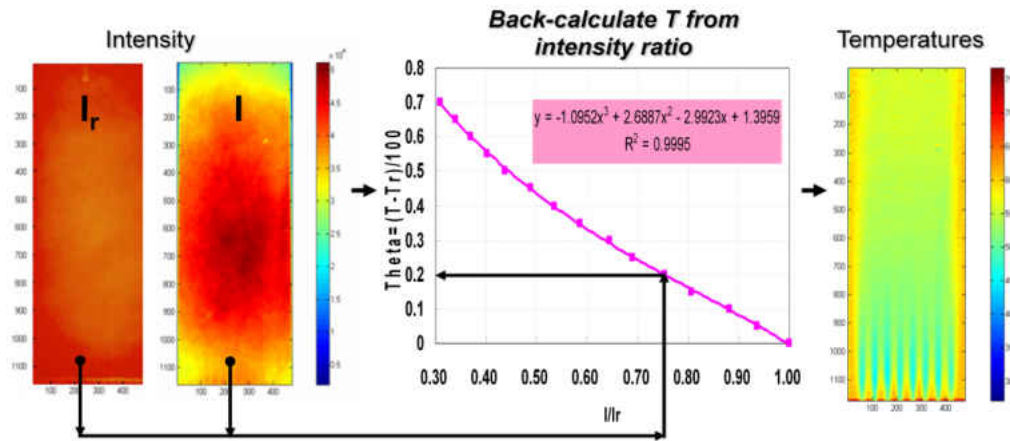
coated with this paint and illuminated with light of 475nm in wavelength, exciting the luminescent molecule. For the paint molecule returns to its original energy state, the added energy is emitted in a form of longer wavelength light or thermal quenching. At higher temperature, the thermal quenching effect increases, thus reduce the emitted intensity. The emitted intensity from the paint is inversely proportional to the temperature. This process is described by Figure 3.12. A full explanation on the experimental use of TSP used in this experiment is outlined by (Liu, 2006). The intensity variation is be captured by a CCD camera and high pass filter.



**Figure 3.12: Jablonski energy level diagram showing luminescence processes of a typical luminophore. ES, fluorescence; ET phosphorescence.**

The pictures captured with the CCD camera are processed using in house codes Matlab script. The captured pictures contain the emitted intensity value by the test section's surface. The Matlab script translates the emitted intensity into temperature value by the use of a calibration curve. The calibration curve is produced by comparing

the emitted intensity ratio with known temperatures. The surface undergoes heat treatment after 8 layer of TSP are applied. It takes about two to three hours for the surface temperature to reach a steady state inside the test section.



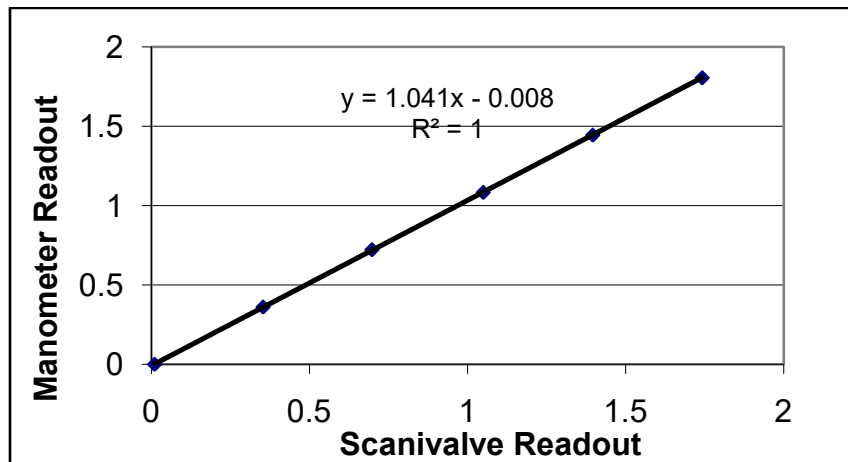
**Figure 3.13: TSP Processes**

### *Kiel Probe*

Kiel Probe is utilized to take static pressure measurement. The Kiel probe essentially is the Pitot probe but less dependent on incoming flow. All pressure data is measure by a Scani-valve. The system is calibrated with the water manometer for accurate results.



**Figure 3.14: Scani-valve and Calibration System**



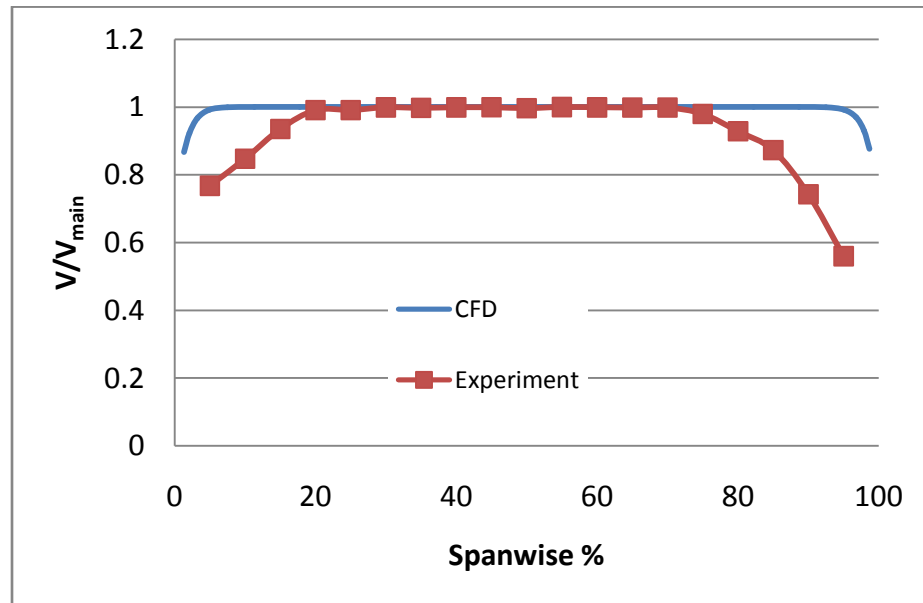
**Figure 3.15: Correction Factor of the Scani-valve System**

## CHAPTER 4: VALIDATION

### Experimental Validation

#### Mainstream Condition

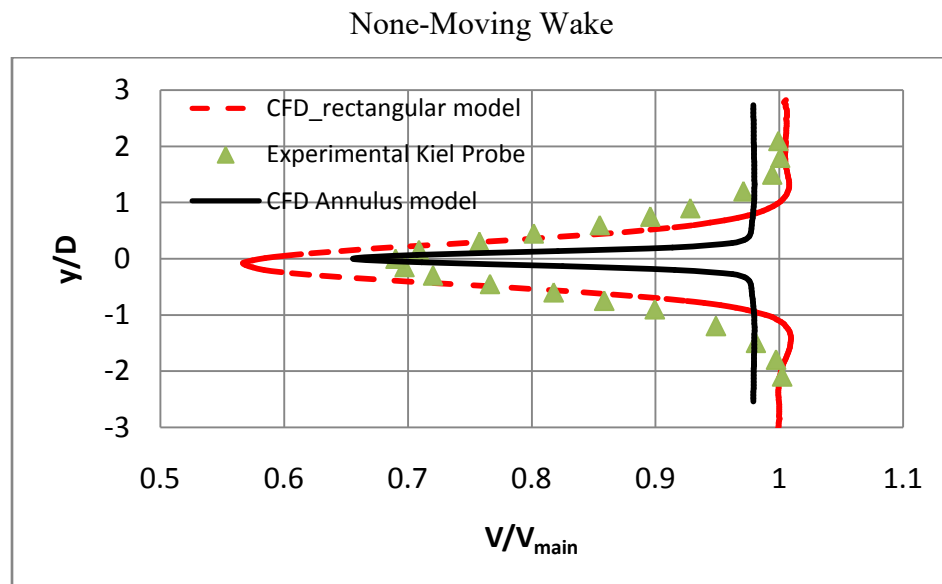
A good CFD model is a proven CFD model. In this age of CFD, many researchers blindly trust their models. As researcher, we need to move away from this practice. CFD result is much more meaningful when it is accompanied by recent and past experiments.



**Figure 4.1: Span Wise Velocity Profile**

The first validation is the mainstream profile. The test section has an annular shaped cross section. The velocity profile was measured using by Pitot tube and hot wire anemometer. The chosen location for the span wise velocity profile in the test section is at  $x/D = 40$  downstream from the spoke. The pressure value is taken at  $0^\circ$  pitch wise and

ranging from the hub to the shroud (span wise). The profile is also extracted from the CFD model. Both the experimental rig and the CFD model show the boundary layer due to the wall Figure 4.1 shows that two curves do not match near the wall. This discrepancy is caused by the different starting length of the experiment and the CFD model. This discrepancy will essentially decrease the effective blowing ratio of the CFD model when compared to the experimental result. The final CFD result will be slightly off compared to the experimental result, but the overall CFD result still show the effect of BR and Sr.



**Figure 4.2: Stationary Spoke Velocity Profile**

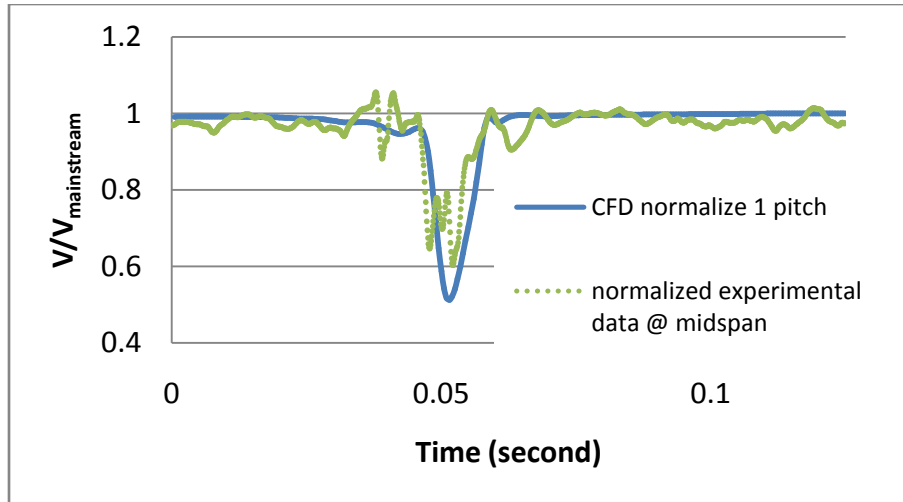
Velocity profile is also taken by using Kiel probe behind the spoke. The wake generator is held stationary with the blower at maximum speed. This positioning will show the effects of the non moving spoke on the normal flow field. The probe is located



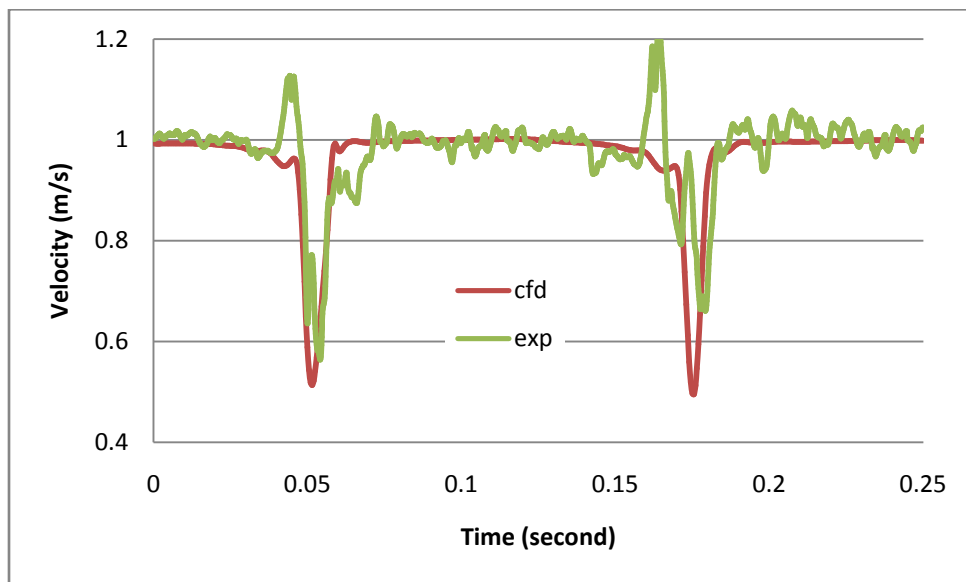
downstream of the spoke with  $x/D_s = 5$ . The velocity right behind the spoke decreases significantly. The speed lost is dependent on the downstream distance and the main stream velocity. The further the distance downstream, the smaller the spoke's effect has on the flow. Data is also extracted at the same location in the CFD model. To maximize the effects of the wake, the data is taken in the 50% radius span. At the 50% radius span, boundary layer has no effect on wake phenomena. Figure 4.2 shows the comparison between the experimental data and the CFD results. The results are comparable. The CFD captures the effect of the wake. With this result, we can move to the effect of the moving wake.

#### Moving Wake

The experiment result the moving wake similar to that of the stationary wake. There is more turbulence in the moving wake case. The effects of the wake on the flow field are captured perfectly by the hot wire anemometry. Figure 4.3 show the wake effect strength of the experimental and CFD are very similar. Figure 4.4 show the two period of wake for the CFD model is right on top of the experimental result. The CFD rotational speed perfectly models the wake generator at  $Sr = 0.1$ . The CFD result however did not capture the turbulent intensity of the flow field like that of the experimental result. This can cause the cooling effectiveness further downstream to be higher than the experimental result.



**Figure 4.3: Transient Wake Profile**

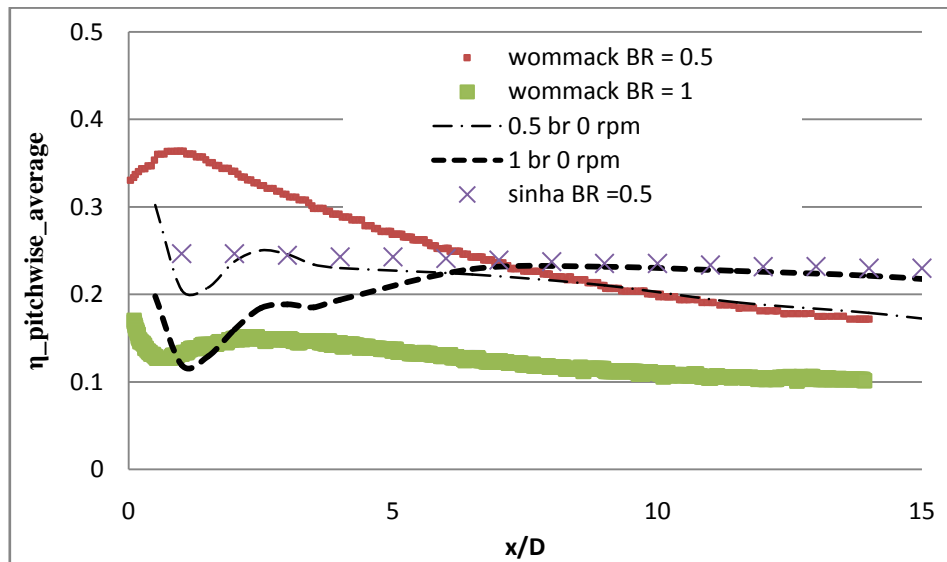


**Figure 4.4: Transient Wake Profile in Two Periods**

#### Film Cooling Validation

The main flow field is only one part of the study. The film cooling part of the model is very important. Again, in the CFD model, the mesh region near the cooling

hole is very fine. The small cell size will help capture the effects of the wake on the film cooling. To validate the film cooling model, the spoke is moved to the wall and far away from the film cooling hole. The wake has no effect on film cooling. The velocity profile is extracted near the film cooling hole. The velocity profile with the spoke near the wall is identical to that of the main stream without any spoke. The CFD film cooling results are validated by the open literature and in house experiment.



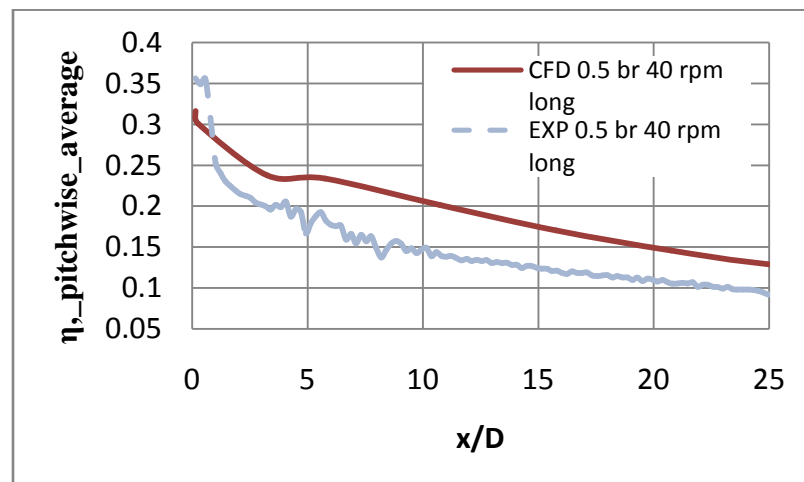
**Figure 4.5: Film cooling Validation**

The base line case was compare to the result of (Womack, 2008). One of his experiment cases is with  $Sr$  of 0 and  $BR$  of 1 and 0.5. Figure 4.5 show the span wise averaged of the film cooling between the Womack results, (Sinha, 1991) result and the CFD result. Compared to Womack result, the CFD result of the case with  $BR = 0.5$  has lower eta value near the cooling hole and compare very well with  $x/D$  greater than 6. CFD result of case with  $BR = 1.0$ , the result is inverse of the previous case. Eta value of

the BR =1 case is similar to that of Womack near the cooling hole, but higher with  $x/D$  is greater than 6. The CFD result matches perfectly with Sinha's result. The data from the literatures vary greatly when comparing only one or two parameter. The main idea from Figure 4.5 is the data fall within the reasonable area.

#### Experimental Validation of Wake Effect on Film Cooling

To further validate the CFD model, one experimental result of film cooling with wake passing was compared to CFD. Due to time constraints, only one experimental result was available. The CFD model was modified to have the increased distance between the spoke and film cooling holes to  $x/D_s = 5$  to match the experiment apparatus. The modified case is name "0.5BR 40 rpm long". The word long indicates the longer distance between the spoke and the film cooling holes. The CFD results fall just a little above the experimental data. The trenches of both curves are almost identical. With this validation, the CFD is confidently predicting the full test matrix.



**Figure 4.6: BR 0.5 Sr 0.1 Long Distance Validation**

## CHAPTER 5: THE EFFECT OF WAKE ON FILM COOLING PREDICTION

### RANS Transient

The physical attributes of the wake effect can only be explained in RANS transient model. The wake effect is very turbulent, therefore the solution model is transient in its true essence. However, the time step in this study was not small enough to capture the true turbulent intensity in the real flow. The CFD model still captures the significant wake effect on film cooling. Figures 5.1 through 5.11 show the temperature contour of the surface as the wake passes. The picture is 2.5 milliseconds apart, represented by the difference of 5 time steps. Figures 5.1 through 5.11 also list the location of the spoke relative to the film cooling area. The first and last film holes are located at  $12^\circ$  and  $18^\circ$  within the test section respectively. As the spoke passes by the film cooling area, the temperature near the film cooling holes increases. Again, the CFD film cooling model is actually film heating. The cooling temperature is hotter than the mainstream temperature. The velocity of the mainstream, above the film cooling holes, decreases by almost 30%. The temporary loss of speed is due to the wake effect. The temporary loss of speed increases the local BR. Since the wake effect is a strong function of the  $x/D$ , only the area near the cooling holes has an increase in cooling effectiveness. However, the wake has a negative effect on the cooling effectiveness further downstream. The cooling blanket is getting thinner as the cooling fluid travels further downstream. With a thin film cooling blanket, the wake is disrupting the film rather than enhancing it. Furthermore, as the

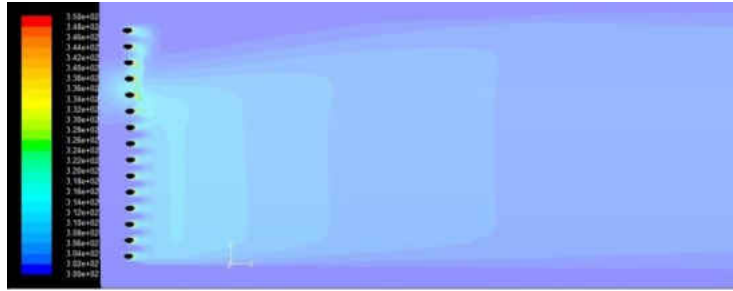
film cooling leaves the film holes, it can actually follow the wake vortex and travel upstream slightly. This phenomenon can only happen if the wake is very close to the spoke.



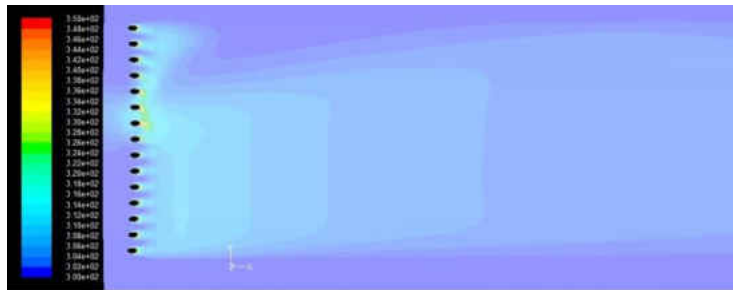
**Figure 5.1: Temperature Contour of Case BR 1 Sr 0.1 at TS = 125 and Spoke Location = 13.2°**



**Figure 5.2 Temperature Contour of Case BR 1 Sr 0.1 at TS = 130, Spoke Location = 14.0°**



**Figure 5.3: Temperature Contour of Case BR 1 Sr 0.1 at TS = 135, Spoke Location = 14.8°**



**Figure 5.4: Temperature Contour of Case BR 1 Sr 0.1 at TS = 140, Spoke Location = 15.6°**



**Figure 5.5: Temperature Contour of Case BR 1 Sr 0.1 at TS = 145, Spoke Location = 16.4°**

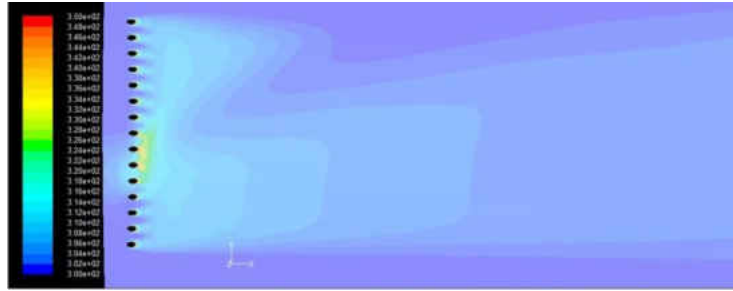


Figure 5.6: Temperature Contour of Case BR 1 Sr 0.1 at TS = 150, Spoke Location = 17.2°



Figure 5.7: Temperature Contour of Case BR 1 Sr 0.1 at TS = 155, Spoke Location = 18.0°



Figure 5.8: Temperature Contour of Case BR 1 Sr 0.1 at TS = 160, Spoke Location = 18.8°





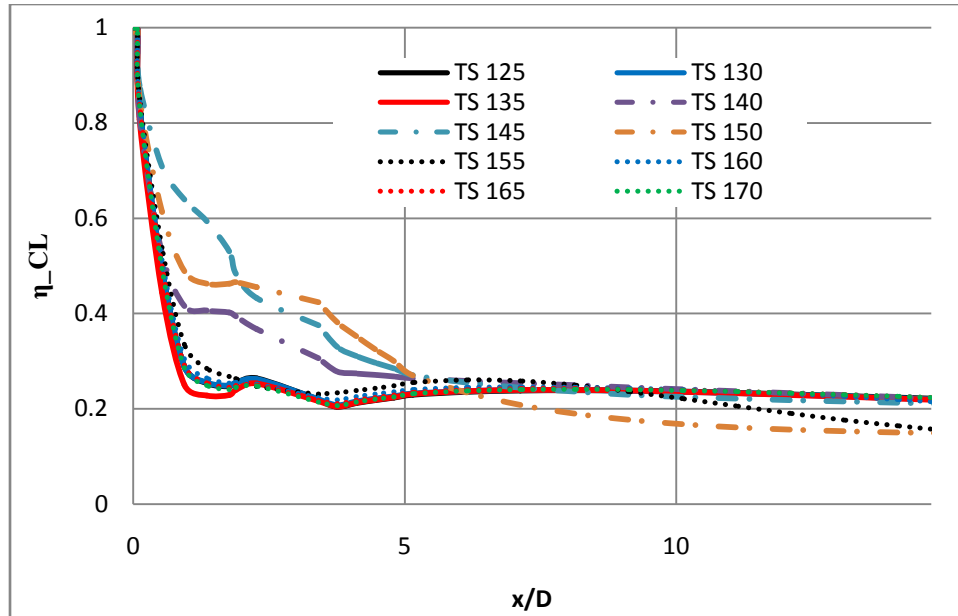
**Figure 5.9: Temperature Contour of Case BR 1 Sr 0.1 at TS = 165, Spoke Location = 19.6°**



**Figure 5.10: Temperature Contour of Case BR 1 Sr 0.1 at TS = 170, Spoke Location = 20.4°**

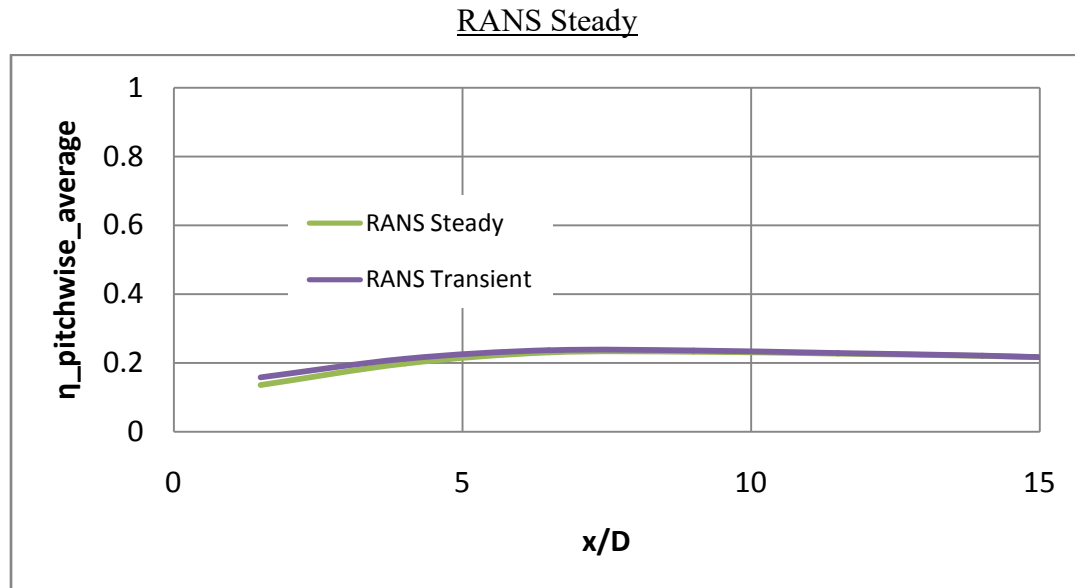


**Figure 5.11: Temperature Contour of Case BR 1 Sr 0.1 at TS = 175, Spoke Location = 21.2°**



**Figure 5.12: Transient RANS Centerline Effectiveness of Case BR 1 Sr 0.1**

Figure 5.13 shows the film cooling effectiveness at the center line every 2.5 millisecond. As the wake moves toward the center line of the middle hole, the cooling effectiveness improves from 0.3 to over 0.6. The film cooling effectiveness downstream decreases after the spoke passes the cooling hole.



**Figure 5.13: RANS steady VS RANS Transient**

Steady RANS was utilized in order to save time. The difference between steady RANS and transient RANS is the time averaging. Steady RANS produces the overall effect of the model. The transient RANS for case BR 1 Sr 0.1 was run with 250 time step. The average of the entire temperature contour at every time step is should equal to the value of the temperature contour of the steady RANS. Figure 5.13 shows the comparison between steady RANS and time average transient RANS. The steady RANS under predicts the cooling effectiveness of the transient RANS near film cooling holes region. The discrepancy is very small. With steady RANS, we can see the overall effect of between BR and Sr. Figure 5.14 shows the result of full test matrix with some other cases. Figure 5.14 shows no change in cooling effectiveness downstream from varying

Sr. The film cooling effectiveness, near the cooling holes, increase as the Sr increases from 0.1 to 0.3. This phenomenon was also captured in Womack and Funazaki papers.

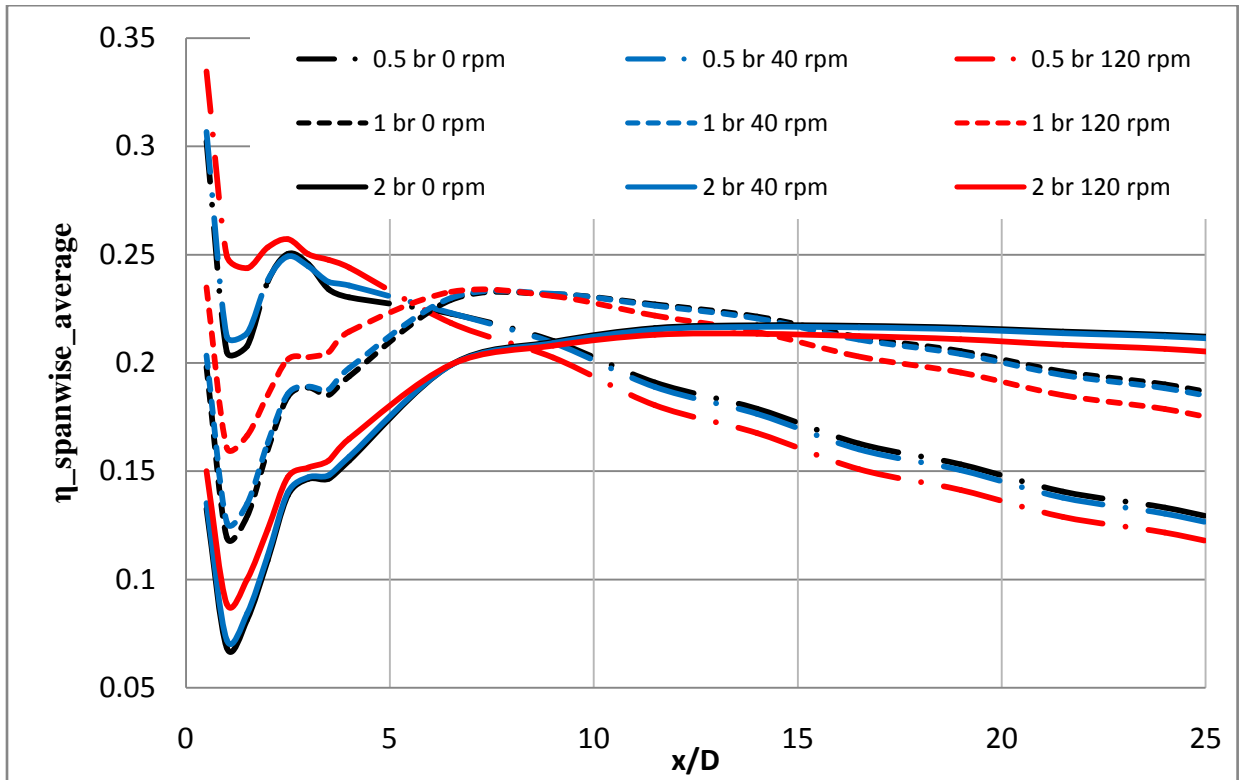


Figure 5.14: Steady RANS Full Testing Matrix

## CHAPTER 6: CONCLUSIONS AND FUTURE WORK

The effect of wake on film cooling is both positive and negative. The film cooling effectiveness is greatly increased as the wake pass by the film cooling holes. However, this positive effect lasts only in several milliseconds. In the averaged scheme, this positive effect can be negligible. The overall result of the CFD model is only depending on BR. The result in this study is in no mean to say that the wake have no important value on film cooling. Again, the maximum Sr value in this study is 0.3. Even though the Sr value matches engine condition, the number of passing wakes is much less than engine condition.

In the current study, at 120 RPM, only 1440 wakes pass every minute. In engine condition, at 3600 RPM, more than 250,000 wakes pass every minute. With more wakes pass the film cooling, time step with high cooling effectiveness increases; therefore increasing the overall averaged film cooling effectiveness.

### Future Work

This study is only in its infancy. With This CFD model, the boundary condition can be changed to full engine condition with full rotational speed. The effect of the distanced between wake and film cooling hole is another parameter that needs to be considered. The cooling effectiveness decrease by half when the film cooling hole is moved away from the spoke by  $x/D_s = 5$ . Furthermore, the relationship between the Sr and  $Sr_{cl}$  is still unknown. Whenever there are two fluctuating sources of fluids, the interaction between them is paramount. When all the physical attributes wake are fully

understood, the study can move on to different type of film cooling. Past study of film cooling need to be revisited to make sure it all still applicable with the effect of wake.

One step further would be replacing the spoke an actual rotor. The rotor will provide better engine simulation. The turbine engine is a very complicated system. It is better to slowly step forward from a most simplistic system. If the model doesn't build from a strong foundation, any unexplained phenomena will be regarded as unique and will be ignored.

## APPENDIX A: COMPUTER

All meshes and computational run was done on a home build computer. (GAMBIT, v2.4.16) was used for meshing the model while (FLUENT, v12.1) was used for the computational solution. The computer has Window 7 64x operating system. The following is the computer specifications:

Mother board: ASROCK P43TWINS1600 775 P43 RT

CPU: INTEL C2Q Q6600 2.40G 775 8M

RAM: 2Gx4, GSK F2-8500CL5D

Hard drive: HD 160G WD 7K 8M

External Hard drive: 1TB WD

Video Card: VGA PNY VCG88512GXEB-FLB 8800GT RT



## APPENDIX B: JOURNAL FILES

Rotor

```

////////////////////////////////////
/NGHIA TRAN THESIS WAKE GENERATOR
////////////////////////////////////
/ROTATE REGEION MESH////////////////////////////////////
/GEOMETRY PARAMETERS:
$x1 = 3
$x2 = .5
$x3 = .5
$spoke_d = 1.25
$spoke_r = $spoke_d/2
$square_half_edge = $spoke_r+$x2
////////////////////////////////////
/mesh parameter
////////////////////////////////////
$edge_node_1 = 16
$edge_node_2 = 8
$edge_node_3 = 64
$ds_ = .003
$ds_growth_1 = 1.2
$ds_growth_2 = 1.4
$ds_layer_1 = 4
$ds_layer_2 = 5
$volume_grid = $square_half_edge*2/$edge_node_1
////////////////////////////////////
vertex create coordinates 0 0 0
/annulus face
edge create radius 39 startangle 0 endangle 30 xyplane arc
edge create radius 44 startangle 0 endangle 30 xyplane arc
edge create straight "vertex.3" "vertex.5"
edge create straight "vertex.2" "vertex.4"
face create wireframe "edge.3" "edge.2" "edge.1" "edge.4" real
/rotate volume without spoke
volume create translate "face.1" vector 0 0 $x1
/create coor for the spoke
vertex create onedge "edge.7" percentarlength (1-$x2/$x1)
vertex create onedge "edge.5" percentarlength (1-$x2/$x1)
vertex create onedge "edge.7" percentarlength (1-($spoke_d+$x2)/$x1)
vertex create onedge "edge.5" percentarlength (1-($spoke_d+$x2)/$x1)
edge create straight "vertex.12" "vertex.11"
edge create straight "vertex.13" "vertex.10"
vertex create edgeints "edge.13" "edge.14" real
vertex create onedge "edge.7" percentarlength (1-($spoke_r+$x2)/$x1)

```

```

vertex cmove "vertex.14" multiple 1 offset 0 0 0.5
coordinate create cartesian vertices "vertex.14" "vertex.16" "vertex.15"
edge delete "edge.13" lowertopology
edge delete "edge.14" lowertopology
vertex create coordinates $spoke_r 0 0
vertex create coordinates 0 $spoke_r 0
/spoke face
edge create center2points "vertex.14" "vertex.18" "vertex.17" circle
/square volume for better meshing
vertex create coordinates $square_half_edge $square_half_edge 0
vertex create coordinates -$square_half_edge $square_half_edge 0
vertex create coordinates -$square_half_edge -$square_half_edge 0
vertex create coordinates $square_half_edge -$square_half_edge 0
edge create straight "vertex.20" "vertex.19"
edge create straight "vertex.19" "vertex.22"
edge create straight "vertex.20" "vertex.21"
edge create straight "vertex.21" "vertex.22"
edge create straight "vertex.21" "vertex.19"
edge create straight "vertex.20" "vertex.22"
vertex create edgeints "edge.13" "edge.18" real
vertex create edgeints "edge.13" "edge.19" real
edge split "edge.18" vertex "vertex.24" connected
edge split "edge.18" vertex "vertex.23" connected
edge split "edge.19" vertex "vertex.25" connected
edge split "edge.22" vertex "vertex.26" connected
vertex delete "vertex.25" "vertex.24" "vertex.26" "vertex.23"
edge split "edge.13" vertex "vertex.24" connected
edge split "edge.24" vertex "vertex.26" connected
edge split "edge.25" vertex "vertex.23" connected
edge split "edge.26" vertex "vertex.25" connected
edge merge "edge.13" "edge.27" forced
face create wireframe "edge.14" "edge.20" "edge.13" "edge.19" real
face create wireframe "edge.24" "edge.15" "edge.20" "edge.23" real
face create wireframe "edge.25" "edge.17" "edge.23" "edge.18" real
face create wireframe "edge.26" "edge.16" "edge.18" "edge.19" real
edge delete "edge.21" "edge.22" lowertopology
vertex delete "vertex.14" "vertex.16" "vertex.17"
volume create translate "face.9" "face.10" "face.8" "face.7" vector 0 \
-2.4980018e-15 -10
vertex delete "vertex.15"
volume intersect volumes "volume.1" "volume.5" keeporiginals
volume intersect volumes "volume.1" "volume.4" keeporiginals

```

```

volume intersect volumes "volume.1" "volume.2" keeporiginals
volume intersect volumes "volume.1" "volume.3" keeporiginals
volume delete "volume.5" "volume.4" "volume.2" "volume.3" lowertopology
volume subtract "volume.1" volumes "volume.6" "volume.7" "volume.8" \
"volume.9" keeptool
volume delete "volume.1" lowertopology
volume create translate "face.117" "face.59" "face.6" vector $x3 0 0
face connect "face.129" "face.131" real
face connect "face.124" "face.126" real
volume merge "volume.13" "volume.12" "volume.11" real
coordinate activate "c_sys.1"
vertex cmove "vertex.56" "vertex.104" "vertex.55" "vertex.103" multiple 1 \
offset 0 0 (-($x1-2*$square_half_edge))
coordinate activate "c_sys.2"
face create plane "vertex.103" "vertex.104" "vertex.196"
face create plane "vertex.55" "vertex.56" "vertex.195"
volume split "volume.10" faces "face.136" connected
volume split "volume.10" faces "face.137" connected
face connect "face.36" "face.80" real
face connect "face.43" "face.52" real
face connect "face.57" "face.68" real
face connect "face.72" "face.88" real
face connect "face.39" "face.93" real
face connect "face.81" "face.111" real
face connect "face.73" "face.102" real
edge mesh "edge.118" "edge.84" "edge.196" "edge.157" "edge.156" "edge.189" \
"edge.85" "edge.125" "edge.86" "edge.119" "edge.159" "edge.197" "edge.190" \
"edge.87" "edge.126" "edge.158" successive ratio1 1 intervals $edge_node_1
blayer create first $ds_growth $ds_growth_1 rows $ds_layer_1 transition 1 trows \
0 uniform
blayer attach "b_layer.1" face "face.60" "face.87" "face.30" "face.44" \
"face.32" "face.86" "face.62" "face.58" edge "edge.159" "edge.197" \
"edge.86" "edge.119" "edge.84" "edge.196" "edge.157" "edge.118" add
edge mesh "edge.122" "edge.90" "edge.81" "edge.153" "edge.89" "edge.120" \
"edge.154" "edge.82" successive ratio1 1 intervals $edge_node_2
blayer create first $ds_growth $ds_growth_2 rows $ds_layer_2 transition 1 trows \
0 uniform
blayer attach "b_layer.2" volume "volume.8" "volume.9" "volume.6" "volume.7" \
"volume.6" "volume.9" "volume.8" "volume.7" "volume.12" "volume.13" \
"volume.12" "volume.13" "volume.14" "volume.13" "volume.10" "volume.13" \
"volume.10" "volume.13" "volume.13" "volume.14" face "face.60" "face.87" \
"face.30" "face.44" "face.32" "face.86" "face.62" "face.58" "face.140" \

```

```

"face.123" "face.119" "face.122" "face.139" "face.127" "face.143" \
"face.132" "face.120" "face.133" "face.128" "face.142" add
edge mesh "edge.91" "edge.152" successive ratio 1 intervals $edge_node_3
face mesh "face.60" "face.87" "face.30" "face.44" "face.62" "face.86" \
"face.32" "face.58" map size 1
volume mesh "volume.8" cooper source "face.60" "face.62"
volume mesh "volume.9" cooper source "face.87" "face.86"
volume mesh "volume.6" cooper source "face.30" "face.32"
volume mesh "volume.7" cooper source "face.44" "face.58"
face mesh "face.142" map size $volume_grid
face mesh "face.120" submap size $volume_grid
face mesh "face.140" submap size $volume_grid
face mesh "face.123" map size $volume_grid
face delete "face.128" "face.133" onlymesh
face mesh "face.128" "face.133" map size $volume_grid
volume mesh "volume.12" "volume.14" "volume.10" "volume.13" map size
$volume_grid
physics create "rotate air" ctype "FLUID" volume "volume.13" "volume.10" \
"volume.14" "volume.12" "volume.6" "volume.7" "volume.8" "volume.9"
physics create "rotate shroud" btype "WALL" face "face.123" "face.140" \
"face.128" "face.133" "face.120" "face.142" "face.30" "face.87" "face.60" \
"face.44"
physics create "rotate hub" btype "WALL" face "face.132" "face.127" \
"face.122" "face.143" "face.139" "face.119" "face.32" "face.58" "face.62" \
"face.86"
physics create "rotate interface" btype "INTERFACE" face "face.125" \
"face.130" "face.135"
physics create "rotate_periodic_1" btype "SYMMETRY" face "face.2" "face.121"
physics create "rotate_periodic_2" btype "SYMMETRY" face "face.5" "face.134"
physics create "rotate inlet" btype "PRESSURE_INLET" face "face.141" "face.1" \
"face.138"
physics create "spoke" btype "WALL" face "face.89" "face.69" "face.56" \
"face.42"
physics create "rotate interior" btype "INTERIOR" face "face.36" "face.43" \
"face.72" "face.81" "face.73" "face.59" "face.39" "face.57" "face.137" \
"face.136" "face.117" "face.6"

```

## Stator Without Film Cooling

```

////////////////////////////////////
/NGHIA TRAN THESIS WAKE GENERATOR
////////////////////////////////////
/none ROTATE REGEION MESH
////////////////////////////////////
//
/
/
/
/GEOMETRY PARAMETERS:
$x1 = 3
$x2 = .5
$x3 = .5
$spoke_d = 1.25
$spoke_r = $spoke_d/2
$square_half_edge = $spoke_r+$x2
////////////////////////////////////
/mesh parameter
////////////////////////////////////
vertex create coordinates 0 0 0
/annulus face
edge create radius 39 startangle 0 endangle 30 xyplane arc
edge create radius 44 startangle 0 endangle 30 xyplane arc
edge create straight "vertex.3" "vertex.5"
edge create straight "vertex.2" "vertex.4"
face create wireframe "edge.3" "edge.2" "edge.1" "edge.4" real
/rotate volume without spoke
volume create translate "face.1" vector 0 0 3
/create coor for the spoke
vertex create onedge "edge.7" percentarlength 0.8333333333333333
vertex create onedge "edge.5" percentarlength 0.8333333333333333
vertex create onedge "edge.7" percentarlength 0.4166666666666667
vertex create onedge "edge.5" percentarlength 0.4166666666666667
edge create straight "vertex.12" "vertex.11"
edge create straight "vertex.13" "vertex.10"
vertex create edgeints "edge.13" "edge.14" real
vertex create onedge "edge.7" percentarlength 0.625
vertex cmove "vertex.14" multiple 1 offset 0 0 0.5
coordinate create cartesian vertices "vertex.14" "vertex.16" "vertex.15"
edge delete "edge.13" lowertopology

```



```

edge delete "edge.14" lowertopology
vertex create coordinates 0.625 0 0
vertex create coordinates 0 0.625 0
/spoke face
edge create center2points "vertex.14" "vertex.18" "vertex.17" circle
/square volume for better meshing
vertex create coordinates 1.125 1.125 0
vertex create coordinates -1.125 1.125 0
vertex create coordinates -1.125 -1.125 0
vertex create coordinates 1.125 -1.125 0
edge create straight "vertex.20" "vertex.19"
edge create straight "vertex.19" "vertex.22"
edge create straight "vertex.20" "vertex.21"
edge create straight "vertex.21" "vertex.22"
edge create straight "vertex.21" "vertex.19"
edge create straight "vertex.20" "vertex.22"
vertex create edgeints "edge.13" "edge.18" real
vertex create edgeints "edge.13" "edge.19" real
edge split "edge.18" vertex "vertex.24" connected
edge split "edge.18" vertex "vertex.23" connected
edge split "edge.19" vertex "vertex.25" connected
edge split "edge.22" vertex "vertex.26" connected
vertex delete "vertex.25" "vertex.24" "vertex.26" "vertex.23"
edge split "edge.13" vertex "vertex.24" connected
edge split "edge.24" vertex "vertex.26" connected
edge split "edge.25" vertex "vertex.23" connected
edge split "edge.26" vertex "vertex.25" connected
edge merge "edge.13" "edge.27" forced
face create wireframe "edge.14" "edge.20" "edge.13" "edge.19" real
face create wireframe "edge.24" "edge.15" "edge.20" "edge.23" real
face create wireframe "edge.25" "edge.17" "edge.23" "edge.18" real
face create wireframe "edge.26" "edge.16" "edge.18" "edge.19" real
edge delete "edge.21" "edge.22" lowertopology
vertex delete "vertex.14" "vertex.16" "vertex.17"
volume create translate "face.9" "face.10" "face.8" "face.7" vector 0 \
-2.4980018e-15 -10
////////
vertex delete "vertex.15"
volume intersect volumes "volume.1" "volume.5" keeporiginals
volume intersect volumes "volume.1" "volume.4" keeporiginals
volume intersect volumes "volume.1" "volume.2" keeporiginals
volume intersect volumes "volume.1" "volume.3" keeporiginals

```

```

volume delete "volume.5" "volume.4" "volume.2" "volume.3" lowertopology
volume subtract "volume.1" volumes "volume.6" "volume.7" "volume.8" \
  "volume.9" keeptool
volume delete "volume.1" lowertopology
volume create translate "face.117" "face.59" "face.6" vector 0.5 0 0
face connect "face.129" "face.131" real
face connect "face.124" "face.126" real
volume merge "volume.13" "volume.12" "volume.11" real
volume create translate "face.135" "face.130" "face.125" vector 15 0 0
volume merge "volume.12" "volume.14" "volume.15" real
blayer create first 0.005 growth 1.5 total 0.56665 rows 10 transition 1 trows \
  0 uniform
volume delete "volume.10" "volume.13" "volume.8" "volume.9" "volume.6" \
  "volume.7" lowertopology
face merge "face.130" "face.135" "face.125" mergelower
face merge "face.142" "face.147" "face.137" mergelower
face merge "face.140" "face.145" "face.150" mergelower
face merge "face.138" "face.143" "face.148" mergelower
coordinate activate "c_sys.1"
coordinate activate "c_sys.2"
vertex create coordinates 0 0 0
vertex create coordinates 0 0.23622 0
vertex create coordinates 0 -0.23622 0
vertex create coordinates 0 0.47244 0
vertex create coordinates 0 -0.47244 0
vertex create coordinates 0 0.70866 0
vertex create coordinates 0 -0.70866 0
vertex create coordinates 0 0.94488 0
vertex create coordinates 0 -0.94488 0
vertex create coordinates 0 1.1811 0
vertex create coordinates 0 -1.1811 0
vertex create coordinates 0 1.41732 0
vertex create coordinates 0 -1.41732 0
vertex create coordinates 0 1.65354 0
vertex create coordinates 0 -1.65354 0
vertex cmove "vertex.201" "vertex.202" "vertex.203" "vertex.204" "vertex.205" \
  "vertex.206" "vertex.207" "vertex.208" "vertex.209" "vertex.210" \
  "vertex.211" "vertex.212" "vertex.213" "vertex.214" "vertex.215" multiple 1 \
  offset 0 0.07874 0
vertex cmove "vertex.215" "vertex.213" "vertex.211" "vertex.209" "vertex.207" \
  "vertex.205" "vertex.203" "vertex.201" "vertex.202" "vertex.204" \
  "vertex.206" "vertex.208" "vertex.210" "vertex.212" "vertex.214" multiple 1 \

```

```

offset 0.07874 0 0
edge create center2points "vertex.214" "vertex.229" "vertex.245" circle
edge create center2points "vertex.212" "vertex.227" "vertex.244" circle
edge create center2points "vertex.210" "vertex.225" "vertex.243" circle
edge create center2points "vertex.208" "vertex.223" "vertex.242" circle
edge create center2points "vertex.206" "vertex.221" "vertex.241" circle
edge create center2points "vertex.204" "vertex.219" "vertex.240" circle
edge create center2points "vertex.202" "vertex.217" "vertex.239" circle
edge create center2points "vertex.201" "vertex.216" "vertex.238" circle
edge create center2points "vertex.203" "vertex.218" "vertex.237" circle
edge create center2points "vertex.205" "vertex.220" "vertex.236" circle
edge create center2points "vertex.207" "vertex.222" "vertex.235" circle
edge create center2points "vertex.209" "vertex.224" "vertex.234" circle
edge create center2points "vertex.211" "vertex.226" "vertex.233" circle
edge create center2points "vertex.213" "vertex.228" "vertex.232" circle
edge create center2points "vertex.215" "vertex.230" "vertex.231" circle
face create wireframe "edge.330" real
face create wireframe "edge.329" real
face create wireframe "edge.328" real
face create wireframe "edge.327" real
face create wireframe "edge.326" real
face create wireframe "edge.325" real
face create wireframe "edge.324" real
face create wireframe "edge.323" real
face create wireframe "edge.322" real
face create wireframe "edge.321" real
face create wireframe "edge.320" real
face create wireframe "edge.319" real
face create wireframe "edge.318" real
face create wireframe "edge.317" real
face create wireframe "edge.316" real
volume create translate "face.147" "face.148" "face.149" "face.150" \
"face.151" "face.152" "face.153" "face.154" "face.155" "face.156" \
"face.157" "face.158" "face.159" "face.160" "face.161" vector 0 \
3.3306691e-17 1.2
vertex create coordinates 0.02 0.02 0
vertex create coordinates 0.11811 0.11811 0
vertex create coordinates -0.11811 0.11811 0
vertex create coordinates -0.11811 -0.11811 0
vertex create coordinates 0.11811 -0.11811 0
vertex create coordinates 0.02 -0.02 0
vertex create coordinates -0.02 -0.02 0

```

```

vertex create coordinates -0.02 0.02 0
edge create straight "vertex.262" "vertex.263"
edge create straight "vertex.263" "vertex.264"
edge create straight "vertex.264" "vertex.265"
edge create straight "vertex.265" "vertex.262"
edge create straight "vertex.268" "vertex.261"
edge create straight "vertex.261" "vertex.266"
edge create straight "vertex.267" "vertex.266"
edge create straight "vertex.267" "vertex.268"
face create wireframe "edge.352" "edge.351" "edge.350" "edge.353" real
face create wireframe "edge.347" "edge.346" "edge.349" "edge.348" real
face cmove "face.192" "face.193" multiple 1 offset 0 0.23622 0
face cmove "face.193" "face.192" multiple 1 offset 0 -0.23622 0
face cmove "face.193" "face.192" "face.195" "face.194" "face.196" "face.197" \
multiple 1 offset 0 0.70866 0
face cmove "face.197" "face.196" "face.192" "face.193" "face.194" "face.195" \
multiple 1 offset 0 -0.70866 0
face cmove "face.203" "face.202" "face.198" "face.200" "face.201" "face.199" \
multiple 1 offset 0 0.70866 0
face cmove "face.209" "face.208" "face.206" "face.207" "face.204" "face.205" \
multiple 1 offset 0 -0.70866 0
volume create translate "face.213" "face.212" "face.211" "face.200" \
"face.198" "face.202" "face.195" "face.193" "face.196" "face.209" \
"face.207" "face.205" "face.216" "face.219" "face.221" "face.220" \
"face.218" "face.217" "face.204" "face.206" "face.208" "face.197" \
"face.192" "face.194" "face.203" "face.199" "face.201" "face.210" \
"face.215" "face.214" vector 0 3.3306691e-17 1.2
vertex create onedge "edge.433" percentarlength 0.5
vertex create onedge "edge.470" percentarlength 0.5
vertex create onedge "edge.463" percentarlength 0.5
vertex create onedge "edge.581" percentarlength 0.5
face create plane "vertex.503" "vertex.504" "vertex.501"
volume split "volume.42" volumes "volume.13" connected
volume split "volume.13" volumes "volume.43" connected
volume split "volume.41" volumes "volume.14" connected
volume split "volume.14" volumes "volume.44" connected
volume split "volume.40" volumes "volume.15" connected
volume split "volume.15" volumes "volume.45" connected
volume split "volume.39" volumes "volume.16" connected
volume split "volume.16" volumes "volume.46" connected
volume split "volume.38" volumes "volume.17" connected
volume split "volume.17" volumes "volume.47" connected

```

volume split "volume.37" volumes "volume.18" connected  
volume split "volume.18" volumes "volume.48" connected  
volume split "volume.36" volumes "volume.19" connected  
volume split "volume.19" volumes "volume.49" connected  
volume split "volume.35" volumes "volume.20" connected  
volume split "volume.20" volumes "volume.50" connected  
volume split "volume.34" volumes "volume.21" connected  
volume split "volume.21" volumes "volume.51" connected  
volume split "volume.33" volumes "volume.22" connected  
volume split "volume.22" volumes "volume.52" connected  
volume split "volume.32" volumes "volume.23" connected  
volume split "volume.23" volumes "volume.53" connected  
volume split "volume.31" volumes "volume.24" connected  
volume split "volume.24" volumes "volume.54" connected  
volume split "volume.30" volumes "volume.25" connected  
volume split "volume.25" volumes "volume.55" connected  
volume split "volume.29" volumes "volume.26" connected  
volume split "volume.26" volumes "volume.56" connected  
volume split "volume.28" volumes "volume.27" connected  
volume split "volume.27" volumes "volume.57" connected  
volume split "volume.42" faces "face.372" connected keptool  
volume split "volume.13" faces "face.372" connected keptool  
volume split "volume.41" faces "face.372" connected keptool  
volume split "volume.14" faces "face.372" connected keptool  
volume split "volume.40" faces "face.372" connected keptool  
volume split "volume.15" faces "face.372" connected keptool  
volume split "volume.39" faces "face.372" connected keptool  
volume split "volume.16" faces "face.372" connected keptool  
volume split "volume.38" faces "face.372" connected keptool  
volume split "volume.17" faces "face.372" connected keptool  
volume split "volume.37" faces "face.372" connected keptool  
volume split "volume.18" faces "face.372" connected keptool  
volume split "volume.36" faces "face.372" connected keptool  
volume split "volume.19" faces "face.372" connected keptool  
volume split "volume.35" faces "face.372" connected keptool  
volume split "volume.20" faces "face.372" connected keptool  
volume split "volume.34" faces "face.372" connected keptool  
volume split "volume.21" faces "face.372" connected keptool  
volume split "volume.33" faces "face.372" connected keptool  
volume split "volume.22" faces "face.372" connected keptool  
volume split "volume.32" faces "face.372" connected keptool  
volume split "volume.23" faces "face.372" connected keptool

volume split "volume.31" faces "face.372" connected keeptool  
 volume split "volume.24" faces "face.372" connected keeptool  
 volume split "volume.30" faces "face.372" connected keeptool  
 volume split "volume.25" faces "face.372" connected keeptool  
 volume split "volume.29" faces "face.372" connected keeptool  
 volume split "volume.26" faces "face.372" connected keeptool  
 volume split "volume.28" faces "face.372" connected keeptool  
 volume split "volume.27" faces "face.372" connected  
 volume move "volume.57" "volume.56" "volume.55" "volume.54" "volume.53" \  
 "volume.52" "volume.51" "volume.50" "volume.49" "volume.48" "volume.47" \  
 "volume.46" "volume.45" "volume.44" "volume.43" "volume.41" "volume.14" \  
 "volume.40" "volume.15" "volume.39" "volume.16" "volume.38" "volume.17" \  
 "volume.37" "volume.18" "volume.36" "volume.19" "volume.35" "volume.20" \  
 "volume.34" "volume.21" "volume.33" "volume.22" "volume.32" "volume.23" \  
 "volume.31" "volume.24" "volume.30" "volume.25" "volume.29" "volume.26" \  
 "volume.28" "volume.27" "volume.42" "volume.13" "volume.88" "volume.89" \  
 "volume.90" "volume.91" "volume.92" "volume.93" "volume.94" "volume.95" \  
 "volume.96" "volume.97" "volume.98" "volume.99" "volume.100" "volume.101" \  
 "volume.102" "volume.103" "volume.104" "volume.105" "volume.106" \  
 "volume.107" "volume.108" "volume.109" "volume.110" "volume.111" \  
 "volume.112" "volume.113" "volume.114" "volume.115" "volume.116" \  
 "volume.117" dangle 55 vector 0 -1 4.9960036e-16 origin 0 0 0  
 vertex delete "vertex.201" "vertex.202" "vertex.203" "vertex.204" \  
 "vertex.205" "vertex.206" "vertex.207" "vertex.208" "vertex.209" \  
 "vertex.210" "vertex.211" "vertex.212" "vertex.213" "vertex.214" \  
 "vertex.215" "vertex.231" "vertex.232" "vertex.233" "vertex.234" \  
 "vertex.235" "vertex.236" "vertex.237" "vertex.238" "vertex.239" \  
 "vertex.240" "vertex.241" "vertex.242" "vertex.243" "vertex.244" \  
 "vertex.245"  
 volume move "volume.57" "volume.56" "volume.55" "volume.54" "volume.53" \  
 "volume.52" "volume.51" "volume.50" "volume.49" "volume.48" "volume.47" \  
 "volume.46" "volume.45" "volume.44" "volume.43" "volume.41" "volume.14" \  
 "volume.40" "volume.15" "volume.39" "volume.16" "volume.38" "volume.17" \  
 "volume.37" "volume.18" "volume.36" "volume.19" "volume.35" "volume.20" \  
 "volume.34" "volume.21" "volume.33" "volume.22" "volume.32" "volume.23" \  
 "volume.31" "volume.24" "volume.30" "volume.25" "volume.29" "volume.26" \  
 "volume.28" "volume.27" "volume.42" "volume.13" "volume.88" "volume.89" \  
 "volume.90" "volume.91" "volume.92" "volume.93" "volume.94" "volume.95" \  
 "volume.96" "volume.97" "volume.98" "volume.99" "volume.100" "volume.101" \  
 "volume.102" "volume.103" "volume.104" "volume.105" "volume.106" \  
 "volume.107" "volume.108" "volume.109" "volume.110" "volume.111" \  
 "volume.112" "volume.113" "volume.114" "volume.115" "volume.116" \

"volume.117" offset 2.2 0 -1.435  
 vertex create coordinates 2.5 2.5 0  
 vertex create coordinates 0 2.5 0  
 vertex create coordinates 2.5 -2.5 0  
 vertex create coordinates 0 -2.5 0  
 edge create straight "vertex.923" "vertex.922" "vertex.924" "vertex.925"  
 edge create straight "vertex.925" "vertex.923"  
 face create wireframe "edge.1336" "edge.1337" "edge.1339" "edge.1338" real  
 face move "face.656" offset 0 0 -0.85  
 volume create translate "face.656" vector 0 5.5511152e-17 2  
 volume split "volume.57" volumes "volume.12" "volume.118" connected keptool  
 volume split "volume.56" volumes "volume.12" "volume.118" connected keptool  
 volume split "volume.55" volumes "volume.12" "volume.118" connected keptool  
 volume split "volume.54" volumes "volume.12" "volume.118" connected keptool  
 volume split "volume.53" volumes "volume.12" "volume.118" connected keptool  
 volume split "volume.52" volumes "volume.12" "volume.118" connected keptool  
 volume split "volume.51" volumes "volume.12" "volume.118" connected keptool  
 volume split "volume.50" volumes "volume.12" "volume.118" connected keptool  
 volume split "volume.49" volumes "volume.12" "volume.118" connected keptool  
 volume split "volume.48" volumes "volume.12" "volume.118" connected keptool  
 volume split "volume.47" volumes "volume.118" "volume.12" connected keptool  
 volume split "volume.46" volumes "volume.12" "volume.118" connected keptool  
 volume split "volume.45" volumes "volume.12" "volume.118" connected keptool  
 volume split "volume.44" volumes "volume.12" "volume.118" connected keptool  
 volume split "volume.43" volumes "volume.12" "volume.118" connected keptool  
 volume split "volume.116" volumes "volume.118" "volume.12" connected keptool  
 volume split "volume.117" volumes "volume.12" "volume.118" connected keptool  
 volume split "volume.28" volumes "volume.12" "volume.118" connected keptool  
 volume split "volume.27" volumes "volume.12" "volume.118" connected keptool  
 volume split "volume.26" volumes "volume.12" "volume.118" connected keptool  
 volume split "volume.29" volumes "volume.12" "volume.118" connected keptool  
 volume split "volume.114" volumes "volume.12" "volume.118" connected keptool  
 volume split "volume.115" volumes "volume.12" "volume.118" connected keptool  
 volume split "volume.113" volumes "volume.12" "volume.118" connected keptool  
 volume split "volume.25" volumes "volume.12" "volume.118" connected keptool  
 volume split "volume.30" volumes "volume.12" "volume.118" connected keptool  
 volume split "volume.31" volumes "volume.12" "volume.118" connected keptool  
 volume split "volume.24" volumes "volume.12" "volume.118" connected keptool  
 volume split "volume.110" volumes "volume.12" "volume.118" connected keptool  
 volume split "volume.32" volumes "volume.12" "volume.118" connected keptool  
 volume split "volume.23" volumes "volume.12" "volume.118" connected keptool  
 volume split "volume.108" volumes "volume.12" "volume.118" connected keptool



volume split "volume.109" volumes "volume.12" "volume.118" connected keeptool  
volume split "volume.22" volumes "volume.12" "volume.118" connected keeptool  
volume split "volume.107" volumes "volume.12" "volume.118" connected keeptool  
volume split "volume.33" volumes "volume.12" "volume.118" connected keeptool  
volume split "volume.106" volumes "volume.12" "volume.118" connected keeptool  
volume split "volume.104" volumes "volume.12" "volume.118" connected keeptool  
volume split "volume.21" volumes "volume.12" "volume.118" connected keeptool  
volume split "volume.34" volumes "volume.12" "volume.118" connected keeptool  
volume split "volume.105" volumes "volume.12" "volume.118" connected keeptool  
volume split "volume.35" volumes "volume.12" "volume.118" connected keeptool  
volume split "volume.102" volumes "volume.12" "volume.118" connected keeptool  
volume split "volume.20" volumes "volume.12" "volume.118" connected keeptool  
volume split "volume.103" volumes "volume.12" "volume.118" connected keeptool  
volume split "volume.100" volumes "volume.12" "volume.118" connected keeptool  
volume split "volume.36" volumes "volume.12" "volume.118" connected keeptool  
volume split "volume.19" volumes "volume.12" "volume.118" connected keeptool  
volume split "volume.101" volumes "volume.12" "volume.118" connected keeptool  
volume split "volume.99" volumes "volume.12" "volume.118" connected keeptool  
volume split "volume.37" volumes "volume.12" "volume.118" connected keeptool  
volume split "volume.18" volumes "volume.12" "volume.118" connected keeptool  
volume split "volume.98" volumes "volume.12" "volume.118" connected keeptool  
volume split "volume.17" volumes "volume.12" "volume.118" connected keeptool  
volume split "volume.96" volumes "volume.12" "volume.118" connected keeptool  
volume split "volume.38" volumes "volume.12" "volume.118" connected keeptool  
volume split "volume.97" volumes "volume.12" "volume.118" connected keeptool  
volume split "volume.39" volumes "volume.12" "volume.118" connected keeptool  
volume split "volume.16" volumes "volume.12" "volume.118" connected keeptool  
volume split "volume.94" volumes "volume.12" "volume.118" connected keeptool  
volume split "volume.95" volumes "volume.12" "volume.118" connected keeptool  
volume split "volume.92" volumes "volume.12" "volume.118" connected keeptool  
volume split "volume.40" volumes "volume.12" "volume.118" connected keeptool  
volume split "volume.15" volumes "volume.12" "volume.118" connected keeptool  
volume split "volume.93" volumes "volume.12" "volume.118" connected keeptool  
volume split "volume.90" volumes "volume.12" "volume.118" connected keeptool  
volume split "volume.41" volumes "volume.12" "volume.118" connected keeptool  
volume split "volume.91" volumes "volume.12" "volume.118" connected keeptool  
volume split "volume.14" volumes "volume.12" "volume.118" connected keeptool  
volume split "volume.42" volumes "volume.12" "volume.118" connected keeptool  
volume split "volume.88" volumes "volume.12" "volume.118" connected keeptool  
volume split "volume.13" volumes "volume.12" "volume.118" connected keeptool  
volume split "volume.89" volumes "volume.12" "volume.118" connected keeptool  
volume delete "volume.125" "volume.119" "volume.121" "volume.123" \



"volume.150" "volume.127" "volume.129" "volume.131" "volume.133" \  
 "volume.135" "volume.137" "volume.141" "volume.143" "volume.145" \  
 "volume.147" "volume.257" "volume.261" "volume.251" "volume.255" \  
 "volume.243" "volume.245" "volume.233" "volume.235" "volume.229" \  
 "volume.225" "volume.219" "volume.221" "volume.211" "volume.213" \  
 "volume.201" "volume.205" "volume.197" "volume.195" "volume.189" \  
 "volume.185" "volume.177" "volume.179" "volume.171" "volume.173" \  
 "volume.169" "volume.167" "volume.159" "volume.157" "volume.153" \  
 "volume.155" "volume.259" "volume.263" "volume.249" "volume.253" \  
 "volume.241" "volume.247" "volume.237" "volume.239" "volume.227" \  
 "volume.231" "volume.223" "volume.217" "volume.209" "volume.215" \  
 "volume.203" "volume.207" "volume.193" "volume.199" "volume.191" \  
 "volume.187" "volume.181" "volume.183" "volume.175" "volume.165" \  
 "volume.161" "volume.163" "volume.151" "volume.140" lowertopology  
 volume split "volume.111" volumes "volume.118" "volume.12" connected keeptool  
 volume split "volume.112" volumes "volume.118" "volume.12" connected keeptool  
 volume delete "volume.266" "volume.268" lowertopology  
 volume delete "volume.47" "volume.111" "volume.112" "volume.116" "volume.57" \  
 "volume.56" "volume.55" "volume.54" "volume.53" "volume.52" "volume.51" \  
 "volume.50" "volume.49" "volume.48" "volume.142" "volume.144" "volume.146" \  
 "volume.148" "volume.117" "volume.28" "volume.27" "volume.26" "volume.29" \  
 "volume.114" "volume.115" "volume.113" "volume.25" "volume.30" "volume.31" \  
 "volume.24" "volume.110" "volume.32" "volume.23" "volume.108" "volume.109" \  
 "volume.22" "volume.107" "volume.33" "volume.106" "volume.104" "volume.21" \  
 "volume.34" "volume.105" "volume.35" "volume.102" "volume.20" "volume.103" \  
 "volume.100" "volume.36" "volume.19" "volume.101" "volume.99" "volume.37" \  
 "volume.18" "volume.98" "volume.226" "volume.228" "volume.230" "volume.232" \  
 "volume.234" "volume.236" "volume.238" "volume.240" "volume.242" \  
 "volume.244" "volume.246" "volume.248" "volume.250" "volume.252" \  
 "volume.254" "volume.256" "volume.258" "volume.260" "volume.262" \  
 "volume.264" lowertopology  
 volume create translate "face.130" vector 1 0 0  
 vertex create onedge "edge.293" percentarlength 0.4  
 vertex create onedge "edge.293" percentarlength 0.6  
 vertex create onedge "edge.3801" percentarlength 0.4  
 vertex create onedge "edge.3801" percentarlength 0.6  
 edge create straight "vertex.2154" "vertex.2156" "vertex.2157" "vertex.2155"  
 edge create straight "vertex.2155" "vertex.2154"  
 face create wireframe "edge.3806" "edge.3805" "edge.3804" "edge.3807" real  
 volume create translate "face.2102" vector 0 -1.66533446e-16 -6  
 volume split "volume.12" volumes "volume.269" connected  
 volume split "volume.269" volumes "volume.270" connected

window modify vertex invisible

```
volume create translate "face.999" "face.975" "face.951" "face.927" \  
"face.909" "face.879" "face.855" "face.831" "face.807" "face.783" \  
"face.759" "face.735" "face.711" "face.687" "face.663" "face.1029" \  
"face.1135" "face.2087" "face.1261" "face.1321" "face.1407" "face.1425" \  
"face.1521" "face.1569" "face.1695" "face.1731" "face.1825" "face.1857" \  
"face.1929" "face.2025" "face.2061" "face.1973" "face.1917" "face.1845" \  
"face.1773" "face.1641" "face.1629" "face.1557" "face.1485" "face.1371" \  
"face.1341" "face.2079" "face.1167" "face.1155" "face.1047" "face.1083" \  
"face.1095" "face.1185" "face.1245" "face.1305" "face.1353" "face.1449" \  
"face.1541" "face.1613" "face.1683" "face.1713" "face.1809" "face.1901" \  
"face.1989" "face.2045" "face.2001" "face.1953" "face.1881" "face.1785" \  
"face.1755" "face.1659" "face.1593" "face.1497" "face.1467" "face.1385" \  
"face.1281" "face.1221" "face.1199" "face.1113" "face.1063" vector 0 \  
-2.2204461e-16 -8  
volume split "volume.270" volumes "volume.288" "volume.290" "volume.348" \  
"volume.318" "volume.346" "volume.347" "volume.321" "volume.345" \  
"volume.286" "volume.316" "volume.287" "volume.320" "volume.319" \  
"volume.291" "volume.285" "volume.284" "volume.344" "volume.343" \  
"volume.293" "volume.314" "volume.323" "volume.294" "volume.342" \  
"volume.295" "volume.312" "volume.313" "volume.325" "volume.283" \  
"volume.324" "volume.341" "volume.281" "volume.340" "volume.296" \  
"volume.311" "volume.326" "volume.280" "volume.327" "volume.297" \  
"volume.310" "volume.298" "volume.279" "volume.309" "volume.328" \  
"volume.339" "volume.278" "volume.299" "volume.308" "volume.329" \  
"volume.338" "volume.277" "volume.307" "volume.330" "volume.336" \  
"volume.337" "volume.301" "volume.276" "volume.300" "volume.335" \  
"volume.302" "volume.305" "volume.306" "volume.331" "volume.332" \  
"volume.274" "volume.303" "volume.304" "volume.333" "volume.334" \  
"volume.289" "volume.317" "volume.322" "volume.315" "volume.292" connected  
volume split "volume.270" volumes "volume.282" "volume.275" connected  
volume create translate "face.673" "face.697" "face.721" "face.745" \  
"face.769" "face.793" "face.817" "face.841" "face.865" "face.889" \  
"face.907" "face.937" "face.961" "face.985" "face.1009" "face.2035" \  
"face.1939" "face.1867" "face.1835" "face.1741" "face.1705" "face.1579" \  
"face.1531" "face.1435" "face.1417" "face.1331" "face.1271" "face.2085" \  
"face.1145" "face.1027" "face.1057" "face.1165" "face.1177" "face.2077" \  
"face.1351" "face.1381" "face.1495" "face.1567" "face.1639" "face.1651" \  
"face.1783" "face.1855" "face.1927" "face.1983" "face.2071" "face.2055" \  
"face.1999" "face.1911" "face.1819" "face.1723" "face.1693" "face.1623" \  
"face.1551" "face.1459" "face.1363" "face.1315" "face.1255" "face.1195" \  
"face.1105" "face.1093" "face.1073" "face.1123" "face.1209" "face.1231" \  

```

```

"face.1291" "face.1395" "face.1477" "face.1507" "face.1603" "face.1669" \
"face.1765" "face.1795" "face.1891" "face.1963" "face.2011" vector 0 \
5.5511152e-17 2
face cmove "face.2925" "face.2538" multiple 1 dangle 180 vector 0 0 \
-5.0045791 origin 2.1968829 1.77165 -1.2886317
face cmove "face.3343" multiple 1 dangle 180 vector 0 0 -5.0045791 origin \
2.6087199 1.77165 -1.2886317
face unite faces "face.3342" "face.3343" "face.3344" real
face cmove "face.2538" multiple 1 dangle 180 vector 0 0 -5.0045791 origin \
1.7850459 1.77165 -1.2886317
volume split "volume.270" faces "face.3342" "face.2925" "face.2538" \
"face.3343" connected keptool
face move "face.3342" dangle 90 vector 0 0 5.0045791 origin 2.1968829 1.77165 \
-6.2932108
face move "face.3343" dangle 90 vector 0 0 -5.0045791 origin 1.7850459 \
1.77165 -1.2886317
face cmove "face.3343" multiple 1 dangle 180 vector 0 0 -5.0045791 origin \
1.7850459 1.9775685 -1.2886317
face unite faces "face.3343" "face.3353" real
face cmove "face.3343" multiple 1 dangle 180 vector 0 0.411837 0 origin \
1.7850459 1.77165 -1.2886317
face unite faces "face.3353" "face.3343" real
face cmove "face.3342" multiple 1 dangle 180 vector 0 -0.6177555 0 origin \
2.1968829 2.3894055 -1.2886317
face unite faces "face.3342" "face.3354" real
volume split "volume.433" faces "face.3342" "face.3353" connected
face cmove "face.2911" "face.2923" multiple 1 dangle 180 vector 0 0 \
-5.0045791 origin 2.1968829 -1.77165 -1.2886317
face cmove "face.3362" multiple 1 dangle 180 vector 0 0 -5.0045791 origin \
2.6087199 -1.77165 -1.2886317
face unite faces "face.3361" "face.3362" "face.3363" real
face cmove "face.2911" "face.2923" multiple 1 dangle 180 vector 0 0 \
-5.0045791 origin 1.7850459 -1.77165 -1.2886317
volume split "volume.270" faces "face.3361" "face.2911" "face.2923" \
"face.3363" "face.3362" connected keptool
face move "face.3361" dangle 90 vector 0 0 -5.0045791 origin 2.1968829 \
-1.77165 -1.2886317
face move "face.3362" "face.3363" dangle 90 vector 0 0 5.0045791 origin \
1.7850459 -1.77165 -6.2932108
face unite faces "face.3363" "face.3362" real
face cmove "face.3363" multiple 1 dangle 180 vector 0 0.411837 0 origin \
1.7850459 -2.183487 -1.2886317

```

```

face cmove "face.3361" multiple 1 dangle 180 vector 0 -0.6177555 0 origin \
  2.1968829 -1.77165 -1.2886317
face unite faces "face.3375" "face.3363" real
face unite faces "face.3361" "face.3376" real
window modify vertex invisible
volume split "volume.437" faces "face.3375" "face.3361" connected
window modify vertex invisible
volume delete "volume.170" "volume.172" "volume.267" "volume.176" \
  "volume.178" "volume.192" "volume.190" "volume.182" "volume.194" \
  "volume.204" "volume.202" "volume.198" "volume.210" "volume.224" \
  "volume.220" "volume.212" "volume.96" "volume.94" "volume.39" "volume.38" \
  "volume.92" "volume.41" "volume.90" "volume.40" "volume.42" "volume.88" \
  lowertopology
edge mesh "edge.4393" "edge.4391" "edge.4390" "edge.4386" "edge.4384" \
  "edge.4387" "edge.4408" "edge.4401" "edge.4770" "edge.4769" "edge.4407" \
  "edge.4405" "edge.1380" "edge.1382" "edge.1381" "edge.1379" "edge.1377" \
  "edge.1378" "edge.2282" "edge.2115" "edge.2110" "edge.2172" "edge.2170" \
  "edge.2173" "edge.2289" "edge.2101" "edge.2099" "edge.1393" "edge.1394" \
  "edge.1392" "edge.1390" "edge.1389" "edge.1391" "edge.2179" "edge.2176" \
  "edge.2251" "edge.5129" "edge.5132" "edge.5130" "edge.5185" "edge.5180" \
  "edge.5191" "edge.4779" "edge.4783" "edge.4784" "edge.4782" "edge.4778" \
  "edge.4775" successive ratio1 1 intervals 3
edge mesh "edge.5131" "edge.5179" "edge.2100" "edge.2177" "edge.2114" \
  "edge.2171" "edge.4417" "edge.4406" successive ratio1 1 intervals 9
blayer create first 0.003 growth 1.2 total 0.016104 rows 4 transition 1 trows \
  0 uniform
blayer attach "b_layer.2" face "face.2922" "face.2544" "face.2545" \
  "face.2118" "face.1047" "face.1029" "face.2543" "face.142" "face.1027" \
  "face.1057" "face.1073" "face.1093" "face.3145" "face.3152" "face.3279" \
  "face.3283" edge "edge.4417" "edge.4417" "edge.4406" "edge.4406" \
  "edge.2114" "edge.2114" "edge.2171" "edge.2171" "edge.2100" "edge.2100" \
  "edge.2177" "edge.2177" "edge.5131" "edge.5131" "edge.5179" "edge.5179" add
blayer create first 0.003 growth 1.4 total 0.0489715 rows 6 transition 1 \
  trows 0 uniform
blayer attach "b_layer.3" face "face.3144" "face.3146" "face.3143" \
  "face.3289" "face.3140" "face.3147" "face.3148" "face.3141" "face.2942" \
  "face.2943" "face.2941" "face.2938" "face.2937" "face.2939" "face.3282" \
  "face.3285" "face.2939" "face.2942" "face.2943" "face.2941" "face.2938" \
  "face.2937" "face.3146" "face.3144" "face.3137" "face.3140" "face.3147" \
  "face.3148" "face.3141" "face.3285" "face.3282" "face.3289" "face.3142" \
  "face.3281" "face.3142" "face.3281" "face.2224" "face.2226" "face.2225" \
  "face.2524" "face.2520" "face.2522" "face.2549" "face.2415" "face.2926" \

```

"face.2925" "face.2534" "face.2539" "face.2537" "face.2228" "face.2547" \  
 "face.2410" "face.2227" "face.2538" "face.2522" "face.2224" "face.2226" \  
 "face.2225" "face.2524" "face.2520" "face.2926" "face.2925" "face.2534" \  
 "face.2539" "face.2537" "face.2538" "face.2415" "face.2549" edge \  
 "edge.5130" "edge.5132" "edge.5129" "edge.5191" "edge.5123" "edge.5135" \  
 "edge.5136" "edge.5124" "edge.4783" "edge.4784" "edge.4782" "edge.4778" \  
 "edge.4775" "edge.4779" "edge.5180" "edge.5185" "edge.1391" "edge.1393" \  
 "edge.1394" "edge.1392" "edge.1390" "edge.1389" "edge.2101" "edge.2099" \  
 "edge.2289" "edge.2094" "edge.2142" "edge.2143" "edge.2095" "edge.2179" \  
 "edge.2176" "edge.2251" "edge.2100" "edge.2177" "edge.5131" "edge.5179" \  
 "edge.1380" "edge.1382" "edge.1381" "edge.1379" "edge.1377" "edge.1378" \  
 "edge.2114" "edge.2171" "edge.2115" "edge.2110" "edge.2282" "edge.2173" \  
 "edge.2170" "edge.2109" "edge.2141" "edge.2140" "edge.2108" "edge.2172" \  
 "edge.4386" "edge.4390" "edge.4393" "edge.4391" "edge.4387" "edge.4384" \  
 "edge.4770" "edge.4769" "edge.4401" "edge.4408" "edge.4405" "edge.4407" \  
 "edge.4406" "edge.4417" add  
 edge mesh "edge.4021" "edge.4014" "edge.4033" "edge.4379" successive ratio1 1 \  
 intervals 32  
 edge mesh "edge.1376" "edge.1372" "edge.2103" successive ratio1 1 intervals \  
 16  
 edge mesh "edge.5134" "edge.5181" "edge.4776" "edge.4786" successive ratio1 1 \  
 intervals 24  
 face modify "face.2544" side "vertex.2392" "vertex.2393"  
 face modify "face.2545" side "vertex.2389" "vertex.2388"  
 face modify "face.2922" side "vertex.2555" "vertex.2398"  
 face modify "face.2118" side "vertex.2400" "vertex.2401"  
 face modify "face.1029" side "vertex.1376" "vertex.1458"  
 face modify "face.1047" side "vertex.950" "vertex.951"  
 face modify "face.2543" side "vertex.946" "vertex.947"  
 face modify "face.142" side "vertex.1394" "vertex.1395"  
 face modify "face.1057" side "vertex.957" "vertex.956"  
 face modify "face.1093" side "vertex.953" "vertex.952"  
 face modify "face.1027" side "vertex.1371" "vertex.1370"  
 face modify "face.1073" side "vertex.1397" "vertex.1396"  
 face modify "face.3152" side "vertex.2561" "vertex.2560"  
 face modify "face.3145" side "vertex.2735" "vertex.2734"  
 face modify "face.3279" side "vertex.2557" "vertex.2556"  
 face modify "face.3283" side "vertex.2737" "vertex.2736"  
 edge mesh "edge.4413" "edge.4416" "edge.4415" "edge.4410" "edge.2109" \  
 "edge.2141" "edge.2140" "edge.2108" "edge.2094" "edge.2142" "edge.2143" \  
 "edge.2095" "edge.5123" "edge.5135" "edge.5136" "edge.5124" successive \  
 ratio1 1 intervals 6

face mesh "face.2940" "face.3152" "face.3279" "face.3145" "face.3283" \  
 "face.673" "face.1057" "face.1093" "face.1027" "face.1073" "face.663" \  
 "face.1047" "face.2543" "face.1029" "face.142" "face.2526" "face.2544" \  
 "face.2545" "face.2118" "face.2922" map  
 volume mesh "volume.319" "volume.288" "volume.318" "volume.289" "volume.348" \  
 map size 1  
 edge msummarize "edge.1375" meshnodes  
 volume mesh "volume.152" "volume.120" "volume.156" map  
 volume mesh "volume.388" "volume.358" "volume.417" "volume.387" "volume.418" \  
 map  
 window modify invisible mesh  
 window modify visible mesh  
 window modify invisible mesh  
 volume delete "volume.149" "volume.154" lowertopology  
 volume delete "volume.162" "volume.160" lowertopology  
 window modify visible mesh  
 edge mesh "edge.4403" "edge.4429" "edge.4419" "edge.4453" "edge.4773" \  
 "edge.4440" "edge.4495" "edge.4514" "edge.4519" "edge.4504" "edge.4531" \  
 "edge.4522" "edge.4562" "edge.4592" "edge.4611" "edge.4583" "edge.4636" \  
 "edge.4620" "edge.4658" "edge.4662" "edge.4681" "edge.4682" "edge.4684" \  
 "edge.4700" "edge.4725" "edge.4716" "edge.4766" "edge.4762" "edge.3726" \  
 "edge.3679" "edge.3732" "edge.3689" "edge.3619" "edge.3582" "edge.3613" \  
 "edge.3572" "edge.3460" "edge.3501" "edge.3470" "edge.3507" "edge.3353" \  
 "edge.3424" "edge.3343" "edge.3418" "edge.3268" "edge.3227" "edge.3277" \  
 "edge.3231" "edge.3161" "edge.3122" "edge.3152" "edge.3118" "edge.3012" \  
 "edge.3053" "edge.3022" "edge.3059" "edge.2905" "edge.2948" "edge.2895" \  
 "edge.2942" "edge.2788" "edge.2826" "edge.2798" "edge.2829" "edge.2647" \  
 "edge.2677" "edge.2643" "edge.2676" "edge.2610" "edge.2535" "edge.2423" \  
 "edge.2498" "edge.2616" "edge.2545" "edge.2433" "edge.2504" "edge.2324" \  
 "edge.2351" "edge.2209" "edge.2290" "edge.2205" "edge.2284" "edge.2320" \  
 "edge.2350" "edge.5119" "edge.5178" "edge.5177" "edge.5107" "edge.5095" \  
 "edge.5176" "edge.5175" "edge.5083" "edge.5071" "edge.5174" "edge.5173" \  
 "edge.5059" "edge.5172" "edge.5047" "edge.5035" "edge.5171" "edge.5170" \  
 "edge.5023" "edge.5169" "edge.5011" "edge.4999" "edge.5168" "edge.4987" \  
 "edge.5167" "edge.5166" "edge.4975" "edge.4963" "edge.5165" successive \  
 ratio 1 intervals 9  
 blayer create first 0.003 growth 1.2 total 0.016104 rows 4 transition 1 trows \  
 0 uniform  
 blayer attach "b\_layer.4" face "face.2535" "face.2556" "face.2562" \  
 "face.2602" "face.2583" "face.2607" "face.2552" "face.2568" "face.2924" \  
 "face.2936" "face.2566" "face.2928" "face.2589" "face.2651" "face.2649" \  
 "face.2645" "face.2636" "face.2687" "face.2658" "face.2632" "face.2654" \

"face.2694" "face.2672" "face.2669" "face.2734" "face.2738" "face.2662" \  
"face.2731" "face.2707" "face.2758" "face.2723" "face.2749" "face.2754" \  
"face.2780" "face.2760" "face.2781" "face.2786" "face.2808" "face.2811" \  
"face.2813" "face.2832" "face.2842" "face.2828" "face.2862" "face.2833" \  
"face.2847" "face.2797" "face.2889" "face.2846" "face.2873" "face.2864" \  
"face.2884" "face.2906" "face.2871" "face.2914" "face.2920" "face.2564" \  
"face.1135" "face.1095" "face.2555" "face.2565" "face.2551" "face.1167" \  
"face.2575" "face.2079" "face.2927" "face.2918" "face.1221" "face.2644" \  
"face.2639" "face.2650" "face.1281" "face.2643" "face.2655" "face.2700" \  
"face.2606" "face.2668" "face.2653" "face.2676" "face.1467" "face.1557" \  
"face.2722" "face.2730" "face.1497" "face.2756" "face.2729" "face.1613" \  
"face.2667" "face.1641" "face.1695" "face.1683" "face.1659" "face.2753" \  
"face.1731" "face.2804" "face.2809" "face.2812" "face.2845" "face.2824" \  
"face.2830" "face.1917" "face.1857" "face.2841" "face.1881" "face.2872" \  
"face.1929" "face.1989" "face.2861" "face.2913" "face.2001" "face.2863" \  
"face.2025" edge "edge.4403" "edge.4403" "edge.4429" "edge.4429" \  
"edge.4453" "edge.4453" "edge.4419" "edge.4419" "edge.4773" "edge.4773" \  
"edge.4440" "edge.4440" "edge.4495" "edge.4495" "edge.4514" "edge.4514" \  
"edge.4504" "edge.4504" "edge.4519" "edge.4519" "edge.4522" "edge.4522" \  
"edge.4531" "edge.4531" "edge.4592" "edge.4592" "edge.4562" "edge.4562" \  
"edge.4611" "edge.4611" "edge.4583" "edge.4583" "edge.4620" "edge.4620" \  
"edge.4636" "edge.4636" "edge.4658" "edge.4658" "edge.4662" "edge.4662" \  
"edge.4682" "edge.4682" "edge.4681" "edge.4681" "edge.4684" "edge.4684" \  
"edge.4700" "edge.4700" "edge.4716" "edge.4716" "edge.4725" "edge.4725" \  
"edge.4762" "edge.4762" "edge.4766" "edge.4766" "edge.2284" "edge.2284" \  
"edge.2205" "edge.2205" "edge.2350" "edge.2350" "edge.2320" "edge.2320" \  
"edge.2498" "edge.2498" "edge.2423" "edge.2423" "edge.2610" "edge.2610" \  
"edge.2535" "edge.2535" "edge.2676" "edge.2676" "edge.2643" "edge.2643" \  
"edge.2788" "edge.2788" "edge.2826" "edge.2826" "edge.2942" "edge.2942" \  
"edge.2895" "edge.2895" "edge.3012" "edge.3012" "edge.3053" "edge.3053" \  
"edge.3118" "edge.3118" "edge.3152" "edge.3152" "edge.3268" "edge.3268" \  
"edge.3227" "edge.3227" "edge.3418" "edge.3418" "edge.3343" "edge.3343" \  
"edge.3460" "edge.3460" "edge.3501" "edge.3501" "edge.3572" "edge.3572" \  
"edge.3613" "edge.3613" "edge.3679" "edge.3679" "edge.3726" "edge.3726" add  
edge mesh "edge.5120" "edge.5186" "edge.4787" "edge.4796" "edge.5190" \  
"edge.5106" "edge.4790" "edge.4791" "edge.4795" "edge.4794" "edge.5192" \  
"edge.4799" "edge.4808" "edge.5108" "edge.5094" "edge.5196" "edge.4806" \  
"edge.4802" "edge.4803" "edge.4807" "edge.4811" "edge.4820" "edge.5096" \  
"edge.5198" "edge.4815" "edge.4819" "edge.4818" "edge.4814" "edge.5082" \  
"edge.5202" "edge.5084" "edge.5204" "edge.4832" "edge.4823" "edge.4827" \  
"edge.4831" "edge.4830" "edge.4826" "edge.5070" "edge.5208" "edge.4835" \  
"edge.4844" "edge.4839" "edge.4843" "edge.4842" "edge.4838" "edge.5210" \



"edge.5072" "edge.5058" "edge.5214" "edge.4856" "edge.4847" "edge.4851" \  
"edge.4855" "edge.4854" "edge.4850" "edge.5216" "edge.5060" "edge.5046" \  
"edge.5220" "edge.4863" "edge.4867" "edge.4868" "edge.4859" "edge.4862" \  
"edge.4866" "edge.5048" "edge.5222" "edge.5226" "edge.5034" "edge.4871" \  
"edge.4880" "edge.4879" "edge.4875" "edge.4874" "edge.4878" "edge.5036" \  
"edge.5228" "edge.5232" "edge.5022" "edge.4883" "edge.4892" "edge.4891" \  
"edge.4887" "edge.4886" "edge.4890" "edge.5024" "edge.5234" "edge.5238" \  
"edge.5010" "edge.4895" "edge.4899" "edge.4903" "edge.4904" "edge.4902" \  
"edge.4898" "edge.5240" "edge.5012" "edge.4998" "edge.5244" "edge.4907" \  
"edge.4911" "edge.4915" "edge.4916" "edge.4914" "edge.4910" "edge.5000" \  
"edge.5246" "edge.5250" "edge.4986" "edge.4919" "edge.4923" "edge.4927" \  
"edge.4928" "edge.4926" "edge.4922" "edge.4988" "edge.5252" "edge.5256" \  
"edge.4974" "edge.4976" "edge.5258" "edge.4931" "edge.4935" "edge.4939" \  
"edge.4940" "edge.4938" "edge.4934" "edge.5262" "edge.4962" "edge.4943" \  
"edge.4947" "edge.4951" "edge.4952" "edge.4950" "edge.4946" "edge.5264" \  
"edge.4964" "edge.4961" "edge.5268" "edge.3688" "edge.3733" "edge.3730" \  
"edge.3690" "edge.3580" "edge.3620" "edge.2061" "edge.2066" "edge.2063" \  
"edge.2065" "edge.2064" "edge.2062" "edge.3583" "edge.3468" "edge.3508" \  
"edge.3618" "edge.2018" "edge.2017" "edge.2015" "edge.2013" "edge.2014" \  
"edge.2016" "edge.3471" "edge.3422" "edge.3354" "edge.3506" "edge.1967" \  
"edge.1965" "edge.1970" "edge.1969" "edge.1968" "edge.1966" "edge.3425" \  
"edge.3275" "edge.3312" "edge.3352" "edge.1917" "edge.1919" "edge.1921" \  
"edge.1922" "edge.1920" "edge.1918" "edge.3278" "edge.3199" "edge.3162" \  
"edge.3311" "edge.1857" "edge.1859" "edge.1861" "edge.1862" "edge.1860" \  
"edge.1858" "edge.3201" "edge.3020" "edge.3060" "edge.3160" "edge.1821" \  
"edge.1823" "edge.1825" "edge.1826" "edge.1824" "edge.1822" "edge.3023" \  
"edge.2946" "edge.2906" "edge.3058" "edge.1775" "edge.1777" "edge.1778" \  
"edge.1776" "edge.1774" "edge.1773" "edge.2949" "edge.2796" "edge.2864" \  
"edge.2904" "edge.1725" "edge.1727" "edge.1729" "edge.1730" "edge.1728" \  
"edge.1726" "edge.2751" "edge.2799" "edge.2714" "edge.2863" "edge.1677" \  
"edge.1682" "edge.1681" "edge.1679" "edge.1678" "edge.1680" "edge.2753" \  
"edge.2614" "edge.2546" "edge.2713" "edge.1629" "edge.1631" "edge.1633" \  
"edge.1634" "edge.1632" "edge.1630" "edge.2617" "edge.2502" "edge.2434" \  
"edge.2544" "edge.1581" "edge.1583" "edge.1585" "edge.1586" "edge.1584" \  
"edge.1582" "edge.2505" "edge.2503" "edge.2388" "edge.2432" "edge.1535" \  
"edge.1533" "edge.1537" "edge.1538" "edge.1536" "edge.1534" "edge.3790" \  
"edge.2288" "edge.2250" "edge.2387" "edge.1487" "edge.1485" "edge.1489" \  
"edge.1490" "edge.1488" "edge.1486" "edge.2291" "edge.2249" "edge.1439" \  
"edge.1437" "edge.1441" "edge.1442" "edge.1440" "edge.1438" "edge.2241" \  
"edge.2285" "edge.2283" "edge.2380" "edge.1426" "edge.1428" "edge.1430" \  
"edge.1429" "edge.1427" "edge.1425" "edge.3795" "edge.2379" "edge.2381" \  
"edge.3794" "edge.1477" "edge.1475" "edge.1473" "edge.1474" "edge.1476" \



"edge.1478" "edge.2499" "edge.2608" "edge.2425" "edge.2422" "edge.1524" \  
"edge.1522" "edge.1521" "edge.1526" "edge.1525" "edge.1523" "edge.2611" \  
"edge.2534" "edge.2537" "edge.2609" "edge.1574" "edge.1572" "edge.1570" \  
"edge.1569" "edge.1571" "edge.1573" "edge.2748" "edge.2705" "edge.2707" \  
"edge.2747" "edge.1622" "edge.1620" "edge.1618" "edge.1617" "edge.1619" \  
"edge.1621" "edge.2789" "edge.2858" "edge.2860" "edge.2787" "edge.1670" \  
"edge.1668" "edge.1666" "edge.1665" "edge.1667" "edge.1669" "edge.2943" \  
"edge.2894" "edge.2896" "edge.2940" "edge.1718" "edge.1717" "edge.1715" \  
"edge.1713" "edge.1714" "edge.1716" "edge.3013" "edge.3052" "edge.3054" \  
"edge.3010" "edge.1766" "edge.1765" "edge.1763" "edge.1761" "edge.1762" \  
"edge.1764" "edge.3196" "edge.3151" "edge.3153" "edge.3194" "edge.1814" \  
"edge.1813" "edge.1811" "edge.1809" "edge.1810" "edge.1812" "edge.3306" \  
"edge.3269" "edge.3266" "edge.3307" "edge.1869" "edge.1871" "edge.1873" \  
"edge.1874" "edge.1872" "edge.1870" "edge.3342" "edge.3419" "edge.1910" \  
"edge.1905" "edge.1907" "edge.1909" "edge.1908" "edge.1906" "edge.3459" \  
"edge.3503" "edge.3500" "edge.3461" "edge.3458" "edge.3502" "edge.1956" \  
"edge.1954" "edge.1953" "edge.1955" "edge.1957" "edge.1958" "edge.3573" \  
"edge.3612" "edge.3614" "edge.3570" "edge.2006" "edge.2005" "edge.2003" \  
"edge.2001" "edge.2002" "edge.2004" "edge.3727" "edge.3724" "edge.3680" \  
"edge.3678" "edge.2049" "edge.2051" "edge.2053" "edge.2054" "edge.2052" \  
"edge.2050" "edge.4428" "edge.4455" "edge.4457" "edge.4461" "edge.4464" \  
"edge.4462" "edge.4458" "edge.4404" "edge.4402" "edge.4420" "edge.4469" \  
"edge.4468" "edge.4418" "edge.4431" "edge.4433" "edge.4448" "edge.4451" \  
"edge.4449" "edge.4434" "edge.4421" "edge.4774" "edge.4512" "edge.4441" \  
"edge.4439" "edge.4471" "edge.4473" "edge.4477" "edge.4480" "edge.4478" \  
"edge.4474" "edge.4494" "edge.4483" "edge.4485" "edge.4489" "edge.4492" \  
"edge.4490" "edge.4486" "edge.4515" "edge.4513" "edge.4496" "edge.4520" \  
"edge.4503" "edge.4505" "edge.4518" "edge.4547" "edge.4560" "edge.4557" \  
"edge.4559" "edge.4546" "edge.4549" "edge.4532" "edge.4530" "edge.4523" \  
"edge.4521" "edge.4552" "edge.4554" "edge.4537" "edge.4540" "edge.4538" \  
"edge.4555" "edge.4593" "edge.4591" "edge.4563" "edge.4561" "edge.4572" \  
"edge.4574" "edge.4578" "edge.4581" "edge.4577" "edge.4573" "edge.4612" \  
"edge.4610" "edge.4584" "edge.4582" "edge.4597" "edge.4600" "edge.4604" \  
"edge.4606" "edge.4603" "edge.4599" "edge.4621" "edge.4619" "edge.4638" \  
"edge.4637" "edge.4623" "edge.4626" "edge.4630" "edge.4632" "edge.4629" \  
"edge.4625" "edge.4659" "edge.4657" "edge.4664" "edge.4663" "edge.4640" \  
"edge.4643" "edge.4647" "edge.4649" "edge.4646" "edge.4642" "edge.4714" \  
"edge.4699" "edge.4686" "edge.4693" "edge.4666" "edge.4669" "edge.4673" \  
"edge.4675" "edge.4672" "edge.4668" "edge.4701" "edge.4683" "edge.4685" \  
"edge.4698" "edge.4712" "edge.4709" "edge.4705" "edge.4703" "edge.4706" \  
"edge.4710" "edge.4726" "edge.4724" "edge.4717" "edge.4715" "edge.4739" \  
"edge.4742" "edge.4732" "edge.4734" "edge.4731" "edge.4741" "edge.4763" \

"edge.4761" "edge.4768" "edge.4767" "edge.4744" "edge.4747" "edge.4751" \  
 "edge.4753" "edge.4750" successive ratio1 1 intervals 3  
 blayer create first 0.003 growth 1.2 total 0.016104 rows 4 transition 1 trows \  
 0 uniform  
 blayer attach "b\_layer.5" face "face.1165" "face.1145" "face.1105" \  
 "face.1123" "face.1177" "face.2085" "face.1195" "face.1209" "face.2077" \  
 "face.1271" "face.1255" "face.1231" "face.1351" "face.1331" "face.1315" \  
 "face.1291" "face.1381" "face.1417" "face.1363" "face.1395" "face.1495" \  
 "face.1435" "face.1459" "face.1477" "face.1551" "face.1507" "face.1567" \  
 "face.1531" "face.1639" "face.1579" "face.1623" "face.1603" "face.1693" \  
 "face.1669" "face.1651" "face.1705" "face.1783" "face.1741" "face.1723" \  
 "face.1765" "face.1855" "face.1835" "face.1819" "face.1795" "face.1927" \  
 "face.1867" "face.1911" "face.1891" "face.1983" "face.1939" "face.1999" \  
 "face.1963" "face.2071" "face.2035" "face.2055" "face.2011" "face.3047" \  
 "face.3236" "face.3237" "face.3339" "face.3054" "face.3230" "face.3240" \  
 "face.3335" "face.3243" "face.3331" "face.3061" "face.3224" "face.3068" \  
 "face.3218" "face.3246" "face.3327" "face.3249" "face.3323" "face.3075" \  
 "face.3212" "face.3082" "face.3206" "face.3252" "face.3319" "face.3255" \  
 "face.3315" "face.3089" "face.3200" "face.3258" "face.3311" "face.3096" \  
 "face.3194" "face.3103" "face.3188" "face.3261" "face.3307" "face.3110" \  
 "face.3182" "face.3264" "face.3303" "face.3117" "face.3176" "face.3267" \  
 "face.3299" "face.3124" "face.3170" "face.3270" "face.3295" "face.3273" \  
 "face.3291" "face.3131" "face.3164" "face.3138" "face.3158" "face.3276" \  
 "face.3287" edge "edge.2290" "edge.2290" "edge.2209" "edge.2209" \  
 "edge.2324" "edge.2324" "edge.2351" "edge.2351" "edge.2504" "edge.2504" \  
 "edge.2433" "edge.2433" "edge.2616" "edge.2616" "edge.2545" "edge.2545" \  
 "edge.2677" "edge.2677" "edge.2647" "edge.2647" "edge.2798" "edge.2798" \  
 "edge.2829" "edge.2829" "edge.2905" "edge.2905" "edge.2948" "edge.2948" \  
 "edge.3022" "edge.3022" "edge.3059" "edge.3059" "edge.3161" "edge.3161" \  
 "edge.3122" "edge.3122" "edge.3277" "edge.3277" "edge.3231" "edge.3231" \  
 "edge.3424" "edge.3424" "edge.3353" "edge.3353" "edge.3470" "edge.3470" \  
 "edge.3507" "edge.3507" "edge.3582" "edge.3582" "edge.3619" "edge.3619" \  
 "edge.3732" "edge.3732" "edge.3689" "edge.3689" "edge.4963" "edge.4963" \  
 "edge.5165" "edge.5165" "edge.4975" "edge.4975" "edge.5166" "edge.5166" \  
 "edge.5167" "edge.5167" "edge.4987" "edge.4987" "edge.4999" "edge.4999" \  
 "edge.5168" "edge.5168" "edge.5169" "edge.5169" "edge.5011" "edge.5011" \  
 "edge.5023" "edge.5023" "edge.5170" "edge.5170" "edge.5171" "edge.5171" \  
 "edge.5035" "edge.5035" "edge.5172" "edge.5172" "edge.5047" "edge.5047" \  
 "edge.5059" "edge.5059" "edge.5173" "edge.5173" "edge.5071" "edge.5071" \  
 "edge.5174" "edge.5174" "edge.5083" "edge.5083" "edge.5175" "edge.5175" \  
 "edge.5095" "edge.5095" "edge.5176" "edge.5176" "edge.5177" "edge.5177" \  
 "edge.5107" "edge.5107" "edge.5119" "edge.5119" "edge.5178" "edge.5178" add

blayer create first 0.003 growth 1.4 total 0.0489715 rows 6 transition 1 \  
trows 0 uniform

blayer attach "b\_layer.6" volume "volume.317" "volume.320" "volume.321" \  
"volume.316" "volume.315" "volume.322" "volume.314" "volume.323" \  
"volume.313" "volume.324" "volume.312" "volume.325" "volume.326" \  
"volume.311" "volume.310" "volume.327" "volume.328" "volume.309" \  
"volume.308" "volume.329" "volume.307" "volume.330" "volume.331" \  
"volume.306" "volume.305" "volume.332" "volume.304" "volume.333" \  
"volume.320" "volume.317" "volume.316" "volume.321" "volume.315" \  
"volume.322" "volume.314" "volume.323" "volume.313" "volume.324" \  
"volume.312" "volume.325" "volume.311" "volume.326" "volume.327" \  
"volume.310" "volume.309" "volume.328" "volume.308" "volume.329" \  
"volume.307" "volume.330" "volume.306" "volume.331" "volume.332" \  
"volume.305" "volume.304" "volume.333" "volume.403" "volume.402" \  
"volume.401" "volume.404" "volume.405" "volume.400" "volume.406" \  
"volume.399" "volume.407" "volume.398" "volume.397" "volume.408" \  
"volume.409" "volume.396" "volume.410" "volume.395" "volume.411" \  
"volume.394" "volume.412" "volume.393" "volume.413" "volume.392" \  
"volume.414" "volume.391" "volume.390" "volume.415" "volume.416" \  
"volume.389" "volume.389" "volume.416" "volume.390" "volume.415" \  
"volume.391" "volume.414" "volume.392" "volume.413" "volume.393" \  
"volume.412" "volume.394" "volume.411" "volume.395" "volume.410" \  
"volume.396" "volume.409" "volume.397" "volume.408" "volume.398" \  
"volume.407" "volume.399" "volume.406" "volume.400" "volume.405" \  
"volume.401" "volume.404" "volume.402" "volume.403" face "face.2556" \  
"face.2602" "face.2568" "face.2583" "face.2924" "face.2928" "face.2645" \  
"face.2651" "face.2632" "face.2687" "face.2669" "face.2694" "face.2731" \  
"face.2738" "face.2707" "face.2749" "face.2760" "face.2780" "face.2808" \  
"face.2811" "face.2828" "face.2832" "face.2847" "face.2889" "face.2884" \  
"face.2873" "face.2906" "face.2920" "face.1095" "face.2564" "face.1167" \  
"face.2565" "face.2079" "face.2918" "face.2644" "face.2650" "face.2655" \  
"face.2700" "face.2668" "face.2676" "face.1557" "face.2730" "face.1613" \  
"face.2756" "face.1641" "face.1683" "face.2753" "face.2804" "face.2812" \  
"face.2824" "face.1917" "face.2841" "face.1989" "face.2872" "face.2863" \  
"face.2913" "face.2055" "face.2071" "face.1983" "face.1999" "face.1911" \  
"face.1927" "face.1819" "face.1855" "face.1723" "face.1783" "face.1651" \  
"face.1693" "face.1623" "face.1639" "face.1551" "face.1567" "face.1459" \  
"face.1495" "face.1363" "face.1381" "face.1315" "face.1351" "face.1255" \  
"face.2077" "face.1177" "face.1195" "face.1105" "face.1165" "face.3158" \  
"face.3276" "face.3164" "face.3273" "face.3170" "face.3270" "face.3176" \  
"face.3267" "face.3182" "face.3264" "face.3188" "face.3261" "face.3194" \  
"face.3258" "face.3200" "face.3255" "face.3206" "face.3252" "face.3212" \

"face.3249" "face.3218" "face.3246" "face.3224" "face.3243" "face.3230" \  
 "face.3240" "face.3236" "face.3237" add  
 blayer create first 0.003 growth 1.4 total 0.0489715 rows 6 transition 1 \  
 trows 0 uniform  
 blayer attach "b\_layer.7" face "face.3139" "face.3130" "face.3133" \  
 "face.3134" "face.3286" "face.3288" "face.3132" "face.3127" "face.3126" \  
 "face.3123" "face.3292" "face.3290" "face.3294" "face.3120" "face.3119" \  
 "face.3125" "face.3116" "face.3296" "face.3118" "face.3113" "face.3112" \  
 "face.3298" "face.3300" "face.3109" "face.3111" "face.3106" "face.3105" \  
 "face.3102" "face.3304" "face.3302" "face.3104" "face.3099" "face.3098" \  
 "face.3095" "face.3308" "face.3306" "face.3310" "face.3312" "face.3088" \  
 "face.3097" "face.3091" "face.3092" "face.3090" "face.3081" "face.3084" \  
 "face.3085" "face.3316" "face.3314" "face.3078" "face.3083" "face.3074" \  
 "face.3077" "face.3320" "face.3318" "face.3322" "face.3071" "face.3070" \  
 "face.3076" "face.3067" "face.3324" "face.3069" "face.3326" "face.3064" \  
 "face.3063" "face.3060" "face.3328" "face.3062" "face.3057" "face.3330" \  
 "face.3332" "face.3053" "face.3056" "face.3055" "face.3050" "face.3049" \  
 "face.3046" "face.3336" "face.3334" "face.3338" "face.3340" "face.3042" \  
 "face.3043" "face.3048" "face.3045" "face.3048" "face.3052" "face.3336" \  
 "face.3338" "face.3340" "face.3045" "face.3042" "face.3043" "face.3055" \  
 "face.3059" "face.3332" "face.3334" "face.3050" "face.3049" "face.3062" \  
 "face.3066" "face.3328" "face.3330" "face.3057" "face.3056" "face.3069" \  
 "face.3073" "face.3324" "face.3326" "face.3064" "face.3063" "face.3076" \  
 "face.3080" "face.3320" "face.3322" "face.3071" "face.3070" "face.3083" \  
 "face.3087" "face.3316" "face.3318" "face.3078" "face.3077" "face.3090" \  
 "face.3094" "face.3312" "face.3314" "face.3085" "face.3084" "face.3097" \  
 "face.3101" "face.3308" "face.3310" "face.3091" "face.3092" "face.3104" \  
 "face.3108" "face.3304" "face.3306" "face.3099" "face.3098" "face.3111" \  
 "face.3115" "face.3300" "face.3302" "face.3106" "face.3105" "face.3118" \  
 "face.3122" "face.3296" "face.3298" "face.3113" "face.3112" "face.3125" \  
 "face.3123" "face.3292" "face.3294" "face.3120" "face.3119" "face.3132" \  
 "face.3136" "face.3288" "face.3290" "face.3127" "face.3126" "face.3139" \  
 "face.3286" "face.3133" "face.3134" "face.2536" "face.2530" "face.2235" \  
 "face.2561" "face.2557" "face.2510" "face.2238" "face.2608" "face.2245" \  
 "face.2511" "face.2559" "face.2508" "face.2576" "face.2577" "face.2648" \  
 "face.2254" "face.2248" "face.2581" "face.2255" "face.2629" "face.2634" \  
 "face.2261" "face.2259" "face.2630" "face.2659" "face.2640" "face.2496" \  
 "face.2263" "face.2499" "face.2657" "face.2663" "face.2275" "face.2665" \  
 "face.2492" "face.2273" "face.2495" "face.2282" "face.2709" "face.2708" \  
 "face.2488" "face.2490" "face.2279" "face.2727" "face.2283" "face.2759" \  
 "face.2757" "face.2486" "face.2484" "face.2784" "face.2291" "face.2761" \  
 "face.2766" "face.2765" "face.2785" "face.2803" "face.2298" "face.2476" \

"face.2798" "face.2478" "face.2802" "face.2310" "face.2305" "face.2840" \  
"face.2304" "face.2850" "face.2471" "face.2838" "face.2836" "face.2317" \  
"face.2468" "face.2470" "face.2314" "face.2876" "face.2869" "face.2464" \  
"face.2867" "face.2466" "face.2875" "face.2912" "face.2911" "face.2907" \  
"face.2326" "face.2921" "face.2923" "face.2536" "face.2530" "face.2561" \  
"face.2235" "face.2238" "face.2510" "face.2508" "face.2557" "face.2559" \  
"face.2608" "face.2245" "face.2511" "face.2576" "face.2248" "face.2581" \  
"face.2254" "face.2648" "face.2577" "face.2261" "face.2629" "face.2255" \  
"face.2634" "face.2259" "face.2630" "face.2659" "face.2496" "face.2640" \  
"face.2657" "face.2499" "face.2263" "face.2275" "face.2273" "face.2665" \  
"face.2663" "face.2492" "face.2495" "face.2709" "face.2282" "face.2708" \  
"face.2279" "face.2490" "face.2488" "face.2484" "face.2727" "face.2283" \  
"face.2759" "face.2757" "face.2486" "face.2784" "face.2291" "face.2761" \  
"face.2766" "face.2765" "face.2785" "face.2803" "face.2802" "face.2478" \  
"face.2476" "face.2298" "face.2798" "face.2310" "face.2304" "face.2305" \  
"face.2840" "face.2471" "face.2850" "face.2317" "face.2314" "face.2836" \  
"face.2838" "face.2468" "face.2470" "face.2464" "face.2869" "face.2867" \  
"face.2876" "face.2875" "face.2466" "face.2912" "face.2911" "face.2907" \  
"face.2326" "face.2921" "face.2923" edge "edge.5120" "edge.5106" \  
"edge.5111" "edge.5112" "edge.5186" "edge.5190" "edge.5108" "edge.5100" \  
"edge.5099" "edge.5094" "edge.5196" "edge.5192" "edge.5198" "edge.5088" \  
"edge.5087" "edge.5096" "edge.5082" "edge.5202" "edge.5084" "edge.5076" \  
"edge.5075" "edge.5204" "edge.5208" "edge.5070" "edge.5072" "edge.5064" \  
"edge.5063" "edge.5058" "edge.5214" "edge.5210" "edge.5060" "edge.5052" \  
"edge.5051" "edge.5046" "edge.5220" "edge.5216" "edge.5222" "edge.5226" \  
"edge.5034" "edge.5048" "edge.5039" "edge.5040" "edge.5036" "edge.5022" \  
"edge.5027" "edge.5028" "edge.5232" "edge.5228" "edge.5016" "edge.5024" \  
"edge.5010" "edge.5015" "edge.5238" "edge.5234" "edge.5240" "edge.5004" \  
"edge.5003" "edge.5012" "edge.4998" "edge.5244" "edge.5000" "edge.5246" \  
"edge.4992" "edge.4991" "edge.4986" "edge.5250" "edge.4988" "edge.4980" \  
"edge.5252" "edge.5256" "edge.4974" "edge.4979" "edge.4976" "edge.4968" \  
"edge.4967" "edge.4962" "edge.5262" "edge.5258" "edge.5264" "edge.5268" \  
"edge.4955" "edge.4956" "edge.4964" "edge.4961" "edge.3733" "edge.3580" \  
"edge.3620" "edge.3688" "edge.3690" "edge.3730" "edge.3694" "edge.3695" \  
"edge.3583" "edge.3468" "edge.3508" "edge.3618" "edge.3577" "edge.3576" \  
"edge.3471" "edge.3422" "edge.3354" "edge.3506" "edge.3465" "edge.3464" \  
"edge.3425" "edge.3275" "edge.3312" "edge.3352" "edge.3359" "edge.3358" \  
"edge.3278" "edge.3199" "edge.3162" "edge.3311" "edge.3272" "edge.3271" \  
"edge.3201" "edge.3020" "edge.3060" "edge.3160" "edge.3166" "edge.3165" \  
"edge.3023" "edge.2946" "edge.2906" "edge.3058" "edge.3017" "edge.3016" \  
"edge.2949" "edge.2796" "edge.2864" "edge.2904" "edge.2910" "edge.2911" \  
"edge.2799" "edge.2751" "edge.2714" "edge.2863" "edge.2793" "edge.2792" \

"edge.2753" "edge.2614" "edge.2546" "edge.2713" "edge.2718" "edge.2717" \  
"edge.2617" "edge.2502" "edge.2434" "edge.2544" "edge.2551" "edge.2550" \  
"edge.2505" "edge.2503" "edge.2388" "edge.2432" "edge.2439" "edge.2438" \  
"edge.3790" "edge.2288" "edge.2250" "edge.2387" "edge.2392" "edge.2391" \  
"edge.2291" "edge.2249" "edge.2253" "edge.2254" "edge.2285" "edge.2244" \  
"edge.2245" "edge.2241" "edge.2382" "edge.2380" "edge.2283" "edge.3795" \  
"edge.3794" "edge.2381" "edge.2383" "edge.2379" "edge.2422" "edge.2425" \  
"edge.2608" "edge.2499" "edge.2426" "edge.2427" "edge.2538" "edge.2534" \  
"edge.2539" "edge.2611" "edge.2609" "edge.2537" "edge.2748" "edge.2708" \  
"edge.2705" "edge.2709" "edge.2707" "edge.2747" "edge.2782" "edge.2789" \  
"edge.2783" "edge.2858" "edge.2787" "edge.2860" "edge.2943" "edge.2899" \  
"edge.2898" "edge.2894" "edge.2896" "edge.2940" "edge.3007" "edge.3006" \  
"edge.3013" "edge.3010" "edge.3054" "edge.3052" "edge.3151" "edge.3156" \  
"edge.3155" "edge.3196" "edge.3194" "edge.3153" "edge.3269" "edge.3264" \  
"edge.3306" "edge.3263" "edge.3307" "edge.3266" "edge.3419" "edge.3347" \  
"edge.3342" "edge.3346" "edge.3459" "edge.3503" "edge.3455" "edge.3454" \  
"edge.3461" "edge.3500" "edge.3502" "edge.3458" "edge.3573" "edge.3567" \  
"edge.3612" "edge.3566" "edge.3614" "edge.3570" "edge.3727" "edge.3724" \  
"edge.3682" "edge.3683" "edge.3678" "edge.3680" "edge.4404" "edge.4396" \  
"edge.4428" "edge.4399" "edge.4402" "edge.4420" "edge.4418" "edge.4423" \  
"edge.4426" "edge.4469" "edge.4468" "edge.4421" "edge.4439" "edge.4443" \  
"edge.4446" "edge.4774" "edge.4512" "edge.4441" "edge.4515" "edge.4494" \  
"edge.4498" "edge.4501" "edge.4513" "edge.4496" "edge.4520" "edge.4503" \  
"edge.4507" "edge.4518" "edge.4505" "edge.4510" "edge.4532" "edge.4530" \  
"edge.4528" "edge.4525" "edge.4521" "edge.4523" "edge.4567" "edge.4593" \  
"edge.4566" "edge.4591" "edge.4563" "edge.4561" "edge.4582" "edge.4589" \  
"edge.4586" "edge.4612" "edge.4610" "edge.4584" "edge.4637" "edge.4617" \  
"edge.4614" "edge.4621" "edge.4619" "edge.4638" "edge.4659" "edge.4657" \  
"edge.4664" "edge.4663" "edge.4655" "edge.4652" "edge.4714" "edge.4695" \  
"edge.4696" "edge.4693" "edge.4686" "edge.4699" "edge.4701" "edge.4698" \  
"edge.4688" "edge.4691" "edge.4683" "edge.4685" "edge.4715" "edge.4722" \  
"edge.4719" "edge.4726" "edge.4724" "edge.4717" "edge.4763" "edge.4761" \  
"edge.4756" "edge.4759" "edge.4767" "edge.4768" add  
edge delete "edge.4396" "edge.4466" "edge.4467" "edge.4399" "edge.4423" \  
"edge.4435" "edge.4438" "edge.4426" "edge.4443" "edge.4771" "edge.4772" \  
"edge.4446" "edge.4498" "edge.4516" "edge.4517" "edge.4501" "edge.4507" \  
"edge.4542" "edge.4545" "edge.4510" "edge.4525" "edge.4533" "edge.4536" \  
"edge.4528" "edge.4567" "edge.4595" "edge.4594" "edge.4566" "edge.4589" \  
"edge.4609" "edge.4608" "edge.4586" "edge.4617" "edge.4635" "edge.4634" \  
"edge.4614" "edge.4655" "edge.4661" "edge.4660" "edge.4652" "edge.4696" \  
"edge.4679" "edge.4678" "edge.4695" "edge.4691" "edge.4737" "edge.4736" \  
"edge.4688" "edge.4722" "edge.4730" "edge.4727" "edge.4719" "edge.4759" \



"edge.4765" "edge.4764" "edge.4756" "edge.2244" "edge.2206" "edge.2207" \  
"edge.2245" "edge.2382" "edge.2317" "edge.2318" "edge.2383" "edge.2426" \  
"edge.2466" "edge.2467" "edge.2427" "edge.2538" "edge.2578" "edge.2579" \  
"edge.2539" "edge.2708" "edge.2644" "edge.2645" "edge.2709" "edge.2782" \  
"edge.2827" "edge.2828" "edge.2783" "edge.2899" "edge.2975" "edge.2974" \  
"edge.2898" "edge.3007" "edge.3087" "edge.3086" "edge.3006" "edge.3156" \  
"edge.3116" "edge.3115" "edge.3155" "edge.3264" "edge.3229" "edge.3228" \  
"edge.3263" "edge.3347" "edge.3387" "edge.3386" "edge.3346" "edge.3455" \  
"edge.3535" "edge.3534" "edge.3454" "edge.3567" "edge.3647" "edge.3646" \  
"edge.3566" "edge.3683" "edge.3759" "edge.3758" "edge.3682" "edge.3694" \  
"edge.3760" "edge.3761" "edge.3695" "edge.3576" "edge.3648" "edge.3649" \  
"edge.3577" "edge.3464" "edge.3536" "edge.3537" "edge.3465" "edge.3358" \  
"edge.3388" "edge.3389" "edge.3359" "edge.3271" "edge.3233" "edge.3234" \  
"edge.3272" "edge.3165" "edge.3120" "edge.3121" "edge.3166" "edge.3016" \  
"edge.3088" "edge.3089" "edge.3017" "edge.2910" "edge.2976" "edge.2977" \  
"edge.2911" "edge.2792" "edge.2830" "edge.2831" "edge.2793" "edge.2717" \  
"edge.2649" "edge.2650" "edge.2718" "edge.2550" "edge.2580" "edge.2581" \  
"edge.2551" "edge.2438" "edge.2468" "edge.2469" "edge.2439" "edge.2391" \  
"edge.2322" "edge.2323" "edge.2392" "edge.2253" "edge.2211" "edge.2212" \  
"edge.2254" "edge.5112" "edge.5138" "edge.5137" "edge.5111" "edge.5100" \  
"edge.5140" "edge.5139" "edge.5099" "edge.5088" "edge.5142" "edge.5141" \  
"edge.5087" "edge.5076" "edge.5144" "edge.5143" "edge.5075" "edge.5064" \  
"edge.5146" "edge.5145" "edge.5063" "edge.5052" "edge.5148" "edge.5147" \  
"edge.5051" "edge.5040" "edge.5150" "edge.5149" "edge.5039" "edge.5028" \  
"edge.5152" "edge.5151" "edge.5027" "edge.5016" "edge.5154" "edge.5153" \  
"edge.5015" "edge.5004" "edge.5156" "edge.5155" "edge.5003" "edge.4992" \  
"edge.5158" "edge.5157" "edge.4991" "edge.4980" "edge.5160" "edge.5159" \  
"edge.4979" "edge.4968" "edge.5162" "edge.5161" "edge.4967" "edge.4956" \  
"edge.5164" "edge.5163" "edge.4955" keepsettings onlymesh  
edge modify "edge.5003" forward  
edge mesh "edge.4396" "edge.4466" "edge.4467" "edge.4399" "edge.4423" \  
"edge.4435" "edge.4438" "edge.4426" "edge.4443" "edge.4771" "edge.4772" \  
"edge.4446" "edge.4498" "edge.4516" "edge.4517" "edge.4501" "edge.4507" \  
"edge.4542" "edge.4545" "edge.4510" "edge.4525" "edge.4533" "edge.4536" \  
"edge.4528" "edge.4567" "edge.4595" "edge.4594" "edge.4566" "edge.4589" \  
"edge.4609" "edge.4608" "edge.4586" "edge.4617" "edge.4635" "edge.4634" \  
"edge.4614" "edge.4655" "edge.4661" "edge.4660" "edge.4652" "edge.4696" \  
"edge.4679" "edge.4678" "edge.4695" "edge.4691" "edge.4737" "edge.4736" \  
"edge.4688" "edge.4722" "edge.4730" "edge.4727" "edge.4719" "edge.4759" \  
"edge.4765" "edge.4764" "edge.4756" "edge.2244" "edge.2206" "edge.2207" \  
"edge.2245" "edge.2382" "edge.2317" "edge.2318" "edge.2383" "edge.2426" \  
"edge.2466" "edge.2467" "edge.2427" "edge.2538" "edge.2578" "edge.2579" \  
"

"edge.2539" "edge.2708" "edge.2644" "edge.2645" "edge.2709" "edge.2782" \  
 "edge.2827" "edge.2828" "edge.2783" "edge.2899" "edge.2975" "edge.2974" \  
 "edge.2898" "edge.3007" "edge.3087" "edge.3086" "edge.3006" "edge.3156" \  
 "edge.3116" "edge.3115" "edge.3155" "edge.3264" "edge.3229" "edge.3228" \  
 "edge.3263" "edge.3347" "edge.3387" "edge.3386" "edge.3346" "edge.3455" \  
 "edge.3535" "edge.3534" "edge.3454" "edge.3567" "edge.3647" "edge.3646" \  
 "edge.3566" "edge.3683" "edge.3759" "edge.3758" "edge.3682" "edge.3694" \  
 "edge.3760" "edge.3761" "edge.3695" "edge.3576" "edge.3648" "edge.3649" \  
 "edge.3577" "edge.3464" "edge.3536" "edge.3537" "edge.3465" "edge.3358" \  
 "edge.3388" "edge.3389" "edge.3359" "edge.3271" "edge.3233" "edge.3234" \  
 "edge.3272" "edge.3165" "edge.3120" "edge.3121" "edge.3166" "edge.3016" \  
 "edge.3088" "edge.3089" "edge.3017" "edge.2910" "edge.2976" "edge.2977" \  
 "edge.2911" "edge.2792" "edge.2830" "edge.2831" "edge.2793" "edge.2717" \  
 "edge.2649" "edge.2650" "edge.2718" "edge.2550" "edge.2580" "edge.2581" \  
 "edge.2551" "edge.2438" "edge.2468" "edge.2469" "edge.2439" "edge.2391" \  
 "edge.2322" "edge.2323" "edge.2392" "edge.2253" "edge.2211" "edge.2212" \  
 "edge.2254" "edge.5112" "edge.5138" "edge.5137" "edge.5111" "edge.5100" \  
 "edge.5140" "edge.5139" "edge.5099" "edge.5088" "edge.5142" "edge.5141" \  
 "edge.5087" "edge.5076" "edge.5144" "edge.5143" "edge.5075" "edge.5064" \  
 "edge.5146" "edge.5145" "edge.5063" "edge.5052" "edge.5148" "edge.5147" \  
 "edge.5051" "edge.5040" "edge.5150" "edge.5149" "edge.5039" "edge.5028" \  
 "edge.5152" "edge.5151" "edge.5027" "edge.5016" "edge.5154" "edge.5153" \  
 "edge.5015" "edge.5004" "edge.5156" "edge.5155" "edge.5003" "edge.4992" \  
 "edge.5158" "edge.5157" "edge.4991" "edge.4980" "edge.5160" "edge.5159" \  
 "edge.4979" "edge.4968" "edge.5162" "edge.5161" "edge.4967" "edge.4956" \  
 "edge.5164" "edge.5163" "edge.4955" successive ratio 1 intervals 6  
 face mesh "face.2598" "face.2579" "face.2615" "face.2625" "face.2704" \  
 "face.2677" "face.2718" "face.2745" "face.2773" "face.2790" "face.2820" \  
 "face.2857" "face.2895" "face.2902" "face.687" "face.711" "face.735" \  
 "face.759" "face.2686" "face.807" "face.831" "face.855" "face.879" \  
 "face.909" "face.927" "face.951" "face.975" "face.999" "face.1009" \  
 "face.985" "face.961" "face.937" "face.907" "face.889" "face.865" \  
 "face.841" "face.817" "face.793" "face.769" "face.745" "face.721" \  
 "face.697" "face.2947" "face.2954" "face.2961" "face.2968" "face.2975" \  
 "face.2982" "face.2989" "face.2996" "face.3003" "face.3010" "face.3017" \  
 "face.3024" "face.3031" "face.3038" map  
 face modify "face.2535" side "vertex.2398" "vertex.2399"  
 face modify "face.2556" side "vertex.2425" "vertex.2424"  
 face modify "face.2602" side "vertex.2420" "vertex.2421"  
 face modify "face.2562" side "vertex.2405" "vertex.2401"  
 face modify "face.2552" side "vertex.2405" "vertex.2406"  
 face modify "face.2568" side "vertex.2410" "vertex.2411"



face modify "face.2583" side "vertex.2419" "vertex.2418"  
face modify "face.2607" side "vertex.2399" "vertex.2426"  
face modify "face.2924" side "vertex.2431" "vertex.2432"  
face modify "face.2936" side "vertex.2426" "vertex.2447"  
face modify "face.2928" side "vertex.2427" "vertex.2428"  
face modify "face.2566" side "vertex.2414" "vertex.2406"  
face modify "face.2649" side "vertex.2447" "vertex.2448"  
face modify "face.2645" side "vertex.2438" "vertex.2437"  
face modify "face.2589" side "vertex.2439" "vertex.2414"  
face modify "face.2651" side "vertex.2434" "vertex.2433"  
face modify "face.2636" side "vertex.2439" "vertex.2443"  
face modify "face.2687" side "vertex.2465" "vertex.2466"  
face modify "face.2632" side "vertex.2461" "vertex.2462"  
face modify "face.2658" side "vertex.2448" "vertex.2449"  
face modify "face.2669" side "vertex.2457" "vertex.2458"  
face modify "face.2672" side "vertex.2449" "vertex.2454"  
face modify "face.2654" side "vertex.2450" "vertex.2443"  
face modify "face.2694" side "vertex.2463" "vertex.2464"  
face modify "face.2662" side "vertex.2450" "vertex.2467"  
face modify "face.2731" side "vertex.2472" "vertex.2471"  
face modify "face.2738" side "vertex.2475" "vertex.2476"  
face modify "face.2734" side "vertex.2454" "vertex.2481"  
face modify "face.2723" side "vertex.2467" "vertex.2477"  
face modify "face.2749" side "vertex.2483" "vertex.2482"  
face modify "face.2707" side "vertex.2486" "vertex.2487"  
face modify "face.2758" side "vertex.2481" "vertex.2488"  
face modify "face.2754" side "vertex.2488" "vertex.2492"  
face modify "face.2780" side "vertex.2497" "vertex.2498"  
face modify "face.2760" side "vertex.2494" "vertex.2493"  
face modify "face.2781" side "vertex.2499" "vertex.2477"  
face modify "face.2808" side "vertex.2504" "vertex.2505"  
face modify "face.2786" side "vertex.2509" "vertex.2492"  
face modify "face.2813" side "vertex.2510" "vertex.2499"  
face modify "face.2811" side "vertex.2501" "vertex.2500"  
face modify "face.2832" side "vertex.2512" "vertex.2511"  
face modify "face.2842" side "vertex.2510" "vertex.2520"  
face modify "face.2828" side "vertex.2515" "vertex.2516"  
face modify "face.2862" side "vertex.2526" "vertex.2509"  
face modify "face.2797" side "vertex.2526" "vertex.2525"  
face modify "face.2889" side "vertex.2531" "vertex.2532"  
face modify "face.2847" side "vertex.2528" "vertex.2527"  
face modify "face.2833" side "vertex.2519" "vertex.2520"

face modify "face.2884" side "vertex.2541" "vertex.2540"  
face modify "face.2864" side "vertex.2537" "vertex.2525"  
face modify "face.2873" side "vertex.2543" "vertex.2542"  
face modify "face.2846" side "vertex.2533" "vertex.2519"  
face modify "face.2914" side "vertex.2554" "vertex.2533"  
face modify "face.2920" side "vertex.2545" "vertex.2544"  
face modify "face.2906" side "vertex.2548" "vertex.2549"  
face modify "face.2871" side "vertex.2537" "vertex.2553"  
face modify "face.1135" side "vertex.1459" "vertex.1458"  
face modify "face.2564" side "vertex.979" "vertex.978"  
face modify "face.1095" side "vertex.975" "vertex.974"  
face modify "face.2555" side "vertex.1498" "vertex.1395"  
window modify invisible mesh  
face modify "face.2575" side "vertex.1459" "vertex.2149"  
face modify "face.1167" side "vertex.1007" "vertex.1006"  
face modify "face.2565" side "vertex.1003" "vertex.1002"  
face modify "face.2551" side "vertex.1499" "vertex.1498"  
face modify "face.1221" side "vertex.1499" "vertex.1523"  
face modify "face.2918" side "vertex.1031" "vertex.1030"  
face modify "face.2079" side "vertex.1035" "vertex.1034"  
face modify "face.2927" side "vertex.2149" "vertex.1598"  
face modify "face.1281" side "vertex.1523" "vertex.1571"  
face modify "face.2650" side "vertex.1059" "vertex.1058"  
face modify "face.2644" side "vertex.1062" "vertex.1063"  
face modify "face.2639" side "vertex.1598" "vertex.1599"  
face modify "face.2643" side "vertex.1599" "vertex.1663"  
face modify "face.2655" side "vertex.1091" "vertex.1090"  
face modify "face.2700" side "vertex.1086" "vertex.1087"  
face modify "face.2606" side "vertex.1639" "vertex.1571"  
face modify "face.2676" side "vertex.1114" "vertex.1115"  
face modify "face.2668" side "vertex.1119" "vertex.1118"  
face modify "face.2653" side "vertex.1663" "vertex.1687"  
face modify "face.1467" side "vertex.1711" "vertex.1639"  
face modify "face.1557" side "vertex.1147" "vertex.1146"  
face modify "face.2730" side "vertex.1142" "vertex.1143"  
face modify "face.1497" side "vertex.1711" "vertex.1730"  
face modify "face.2722" side "vertex.1758" "vertex.1687"  
face modify "face.2667" side "vertex.1730" "vertex.1806"  
face modify "face.2729" side "vertex.1782" "vertex.1758"  
face modify "face.2756" side "vertex.1174" "vertex.1175"  
face modify "face.1613" side "vertex.1170" "vertex.1171"  
face modify "face.1659" side "vertex.1806" "vertex.1846"

face modify "face.1695" side "vertex.1870" "vertex.1782"  
face modify "face.1641" side "vertex.1202" "vertex.1203"  
face modify "face.1683" side "vertex.1198" "vertex.1199"  
face modify "face.1731" side "vertex.1870" "vertex.1912"  
face modify "face.2809" side "vertex.1846" "vertex.1934"  
face modify "face.2804" side "vertex.1233" "vertex.1232"  
face modify "face.2753" side "vertex.1237" "vertex.1236"  
face modify "face.2830" side "vertex.1934" "vertex.2031"  
face modify "face.2845" side "vertex.2007" "vertex.1912"  
face modify "face.2812" side "vertex.1259" "vertex.1258"  
face modify "face.2824" side "vertex.1255" "vertex.1254"  
face modify "face.1857" side "vertex.2007" "vertex.2006"  
face modify "face.1881" side "vertex.2030" "vertex.2031"  
face modify "face.1917" side "vertex.1287" "vertex.1286"  
face modify "face.2841" side "vertex.1283" "vertex.1282"  
face modify "face.1929" side "vertex.2006" "vertex.2054"  
face modify "face.2861" side "vertex.2078" "vertex.2030"  
face modify "face.1989" side "vertex.1310" "vertex.1311"  
face modify "face.2872" side "vertex.1315" "vertex.1314"  
face modify "face.2001" side "vertex.2078" "vertex.2098"  
face modify "face.2025" side "vertex.2054" "vertex.2126"  
face modify "face.2863" side "vertex.1343" "vertex.1342"  
face modify "face.2913" side "vertex.1339" "vertex.1338"  
face modify "face.2011" side "vertex.2105" "vertex.2104"  
face modify "face.2035" side "vertex.2128" "vertex.2129"  
face modify "face.2055" side "vertex.1345" "vertex.1344"  
face modify "face.2071" side "vertex.1349" "vertex.1348"  
face modify "face.1983" side "vertex.1320" "vertex.1321"  
face modify "face.1999" side "vertex.1317" "vertex.1316"  
face modify "face.1939" side "vertex.2060" "vertex.2061"  
face modify "face.1963" side "vertex.2080" "vertex.2081"  
face modify "face.1891" side "vertex.2032" "vertex.2033"  
face modify "face.1867" side "vertex.2013" "vertex.2012"  
face modify "face.1911" side "vertex.1288" "vertex.1289"  
face modify "face.1927" side "vertex.1293" "vertex.1292"  
face modify "face.1795" side "vertex.1960" "vertex.1961"  
face modify "face.1835" side "vertex.1985" "vertex.1984"  
face modify "face.1819" side "vertex.1260" "vertex.1261"  
face modify "face.1855" side "vertex.1264" "vertex.1265"  
face modify "face.1741" side "vertex.1916" "vertex.1917"  
face modify "face.1765" side "vertex.1936" "vertex.1937"  
face modify "face.1783" side "vertex.1230" "vertex.1231"

face modify "face.1723" side "vertex.1226" "vertex.1227"  
face modify "face.1669" side "vertex.1850" "vertex.1851"  
face modify "face.1705" side "vertex.1873" "vertex.1872"  
face modify "face.1651" side "vertex.1208" "vertex.1209"  
face modify "face.1693" side "vertex.1205" "vertex.1204"  
face modify "face.1579" side "vertex.1788" "vertex.1789"  
face modify "face.1603" side "vertex.1808" "vertex.1809"  
face modify "face.1623" side "vertex.1176" "vertex.1177"  
face modify "face.1639" side "vertex.1180" "vertex.1181"  
face modify "face.1531" side "vertex.1760" "vertex.1761"  
face modify "face.1507" side "vertex.1736" "vertex.1737"  
face modify "face.1551" side "vertex.1148" "vertex.1149"  
face modify "face.1567" side "vertex.1152" "vertex.1153"  
face modify "face.1435" side "vertex.1692" "vertex.1693"  
face modify "face.1477" side "vertex.1712" "vertex.1713"  
face modify "face.1459" side "vertex.1120" "vertex.1121"  
face modify "face.1495" side "vertex.1124" "vertex.1125"  
face modify "face.1417" side "vertex.1664" "vertex.1665"  
face modify "face.1395" side "vertex.1642" "vertex.1643"  
face modify "face.1363" side "vertex.1092" "vertex.1093"  
face modify "face.1381" side "vertex.1096" "vertex.1097"  
face modify "face.1331" side "vertex.1600" "vertex.1601"  
face modify "face.1291" side "vertex.1576" "vertex.1577"  
face modify "face.1315" side "vertex.1064" "vertex.1065"  
face modify "face.1351" side "vertex.1068" "vertex.1069"  
face modify "face.1255" side "vertex.1036" "vertex.1037"  
face modify "face.2077" side "vertex.1040" "vertex.1041"  
face modify "face.1231" side "vertex.1528" "vertex.1529"  
face modify "face.1271" side "vertex.1553" "vertex.1552"  
face modify "face.2085" side "vertex.2146" "vertex.2147"  
face modify "face.1177" side "vertex.1012" "vertex.1013"  
face modify "face.1195" side "vertex.1008" "vertex.1009"  
face modify "face.1209" side "vertex.1502" "vertex.1503"  
face modify "face.1123" side "vertex.1438" "vertex.1439"  
face modify "face.1145" side "vertex.1460" "vertex.1461"  
face modify "face.1165" side "vertex.984" "vertex.985"  
face modify "face.1105" side "vertex.980" "vertex.981"  
face modify "face.3158" side "vertex.2566" "vertex.2567"  
face modify "face.3276" side "vertex.2562" "vertex.2563"  
face modify "face.3287" side "vertex.2738" "vertex.2739"  
face modify "face.3138" side "vertex.2728" "vertex.2729"  
face modify "face.3131" side "vertex.2723" "vertex.2722"

face modify "face.3291" side "vertex.2740" "vertex.2741"  
face modify "face.3164" side "vertex.2572" "vertex.2573"  
face modify "face.3273" side "vertex.2568" "vertex.2569"  
face modify "face.3124" side "vertex.2717" "vertex.2716"  
face modify "face.3295" side "vertex.2742" "vertex.2743"  
face modify "face.3170" side "vertex.2578" "vertex.2579"  
face modify "face.3270" side "vertex.2574" "vertex.2575"  
face modify "face.3117" side "vertex.2711" "vertex.2710"  
face modify "face.3176" side "vertex.2584" "vertex.2585"  
face modify "face.3267" side "vertex.2581" "vertex.2580"  
face modify "face.3299" side "vertex.2744" "vertex.2745"  
face modify "face.3303" side "vertex.2747" "vertex.2746"  
face modify "face.3264" side "vertex.2586" "vertex.2587"  
face modify "face.3182" side "vertex.2590" "vertex.2591"  
face modify "face.3110" side "vertex.2704" "vertex.2705"  
face modify "face.3103" side "vertex.2699" "vertex.2698"  
face modify "face.3188" side "vertex.2596" "vertex.2597"  
face modify "face.3261" side "vertex.2592" "vertex.2593"  
face modify "face.3307" side "vertex.2748" "vertex.2749"  
face modify "face.3096" side "vertex.2693" "vertex.2692"  
face modify "face.3311" side "vertex.2750" "vertex.2751"  
face modify "face.3194" side "vertex.2602" "vertex.2603"  
face modify "face.3258" side "vertex.2598" "vertex.2599"  
face modify "face.3089" side "vertex.2687" "vertex.2686"  
face modify "face.3200" side "vertex.2608" "vertex.2609"  
face modify "face.3255" side "vertex.2604" "vertex.2605"  
face modify "face.3315" side "vertex.2752" "vertex.2753"  
face modify "face.3082" side "vertex.2681" "vertex.2680"  
face modify "face.3206" side "vertex.2614" "vertex.2615"  
face modify "face.3252" side "vertex.2610" "vertex.2611"  
face modify "face.3319" side "vertex.2754" "vertex.2755"  
face modify "face.3212" side "vertex.2620" "vertex.2621"  
face modify "face.3249" side "vertex.2616" "vertex.2617"  
face modify "face.3075" side "vertex.2674" "vertex.2675"  
face modify "face.3323" side "vertex.2756" "vertex.2757"  
face modify "face.3068" side "vertex.2669" "vertex.2668"  
face modify "face.3218" side "vertex.2626" "vertex.2627"  
face modify "face.3246" side "vertex.2622" "vertex.2623"  
face modify "face.3327" side "vertex.2758" "vertex.2759"  
face modify "face.3061" side "vertex.2663" "vertex.2662"  
face modify "face.3224" side "vertex.2632" "vertex.2633"  
face modify "face.3243" side "vertex.2628" "vertex.2629"

face modify "face.3331" side "vertex.2760" "vertex.2761"  
 face modify "face.3054" side "vertex.2657" "vertex.2656"  
 face modify "face.3335" side "vertex.2762" "vertex.2763"  
 face modify "face.3230" side "vertex.2638" "vertex.2639"  
 face modify "face.3240" side "vertex.2634" "vertex.2635"  
 face modify "face.3236" side "vertex.2645" "vertex.2644"  
 face modify "face.3047" side "vertex.2651" "vertex.2650"  
 face modify "face.3339" side "vertex.2764" "vertex.2765"  
 face modify "face.3237" side "vertex.2640" "vertex.2641"  
 window modify visible mesh  
 face mesh "face.2556" "face.2535" "face.2562" "face.2602" "face.2568" \  
 "face.2583" "face.2552" "face.2607" "face.2566" "face.2924" "face.2928" \  
 "face.2936" "face.2589" "face.2649" "face.2645" "face.2651" "face.2636" \  
 "face.2658" "face.2632" "face.2687" "face.2654" "face.2672" "face.2669" \  
 "face.2694" "face.2662" "face.2734" "face.2731" "face.2738" "face.2723" \  
 "face.2758" "face.2707" "face.2749" "face.2754" "face.2781" "face.2760" \  
 "face.2780" "face.2786" "face.2813" "face.2808" "face.2811" "face.2842" \  
 "face.2862" "face.2828" "face.2832" "face.2797" "face.2833" "face.2847" \  
 "face.2889" "face.2846" "face.2864" "face.2873" "face.2884" "face.2871" \  
 "face.2914" "face.2906" "face.2920" "face.2001" "face.2025" "face.2863" \  
 "face.2913" "face.1929" "face.2861" "face.1989" "face.2872" "face.1857" \  
 "face.1881" "face.1917" "face.2841" "face.2830" "face.2845" "face.2812" \  
 "face.2824" "face.1731" "face.2809" "face.2753" "face.2804" "face.1659" \  
 "face.1695" "face.1641" "face.1683" "face.2667" "face.2729" "face.1613" \  
 "face.2756" "face.1497" "face.2722" "face.1557" "face.2730" "face.1467" \  
 "face.2653" "face.2668" "face.2676" "face.2606" "face.2643" "face.2655" \  
 "face.2700" "face.1281" "face.2639" "face.2644" "face.2650" "face.1221" \  
 "face.2927" "face.2079" "face.2918" "face.2551" "face.2575" "face.1167" \  
 "face.2565" "face.1135" "face.2555" "face.1095" "face.2564" "face.1123" \  
 "face.1145" "face.1105" "face.1165" "face.1209" "face.2085" "face.1177" \  
 "face.1195" "face.1231" "face.1271" "face.1255" "face.2077" "face.1291" \  
 "face.1331" "face.1315" "face.1351" "face.1395" "face.1417" "face.1363" \  
 "face.1381" "face.1435" "face.1477" "face.1459" "face.1495" "face.1507" \  
 "face.1531" "face.1551" "face.1567" "face.1579" "face.1603" "face.1623" \  
 "face.1639" "face.1669" "face.1705" "face.1651" "face.1693" "face.1741" \  
 "face.1765" "face.1723" "face.1783" "face.1795" "face.1835" "face.1819" \  
 "face.1855" "face.1867" "face.1891" "face.1911" "face.1927" "face.1939" \  
 "face.1963" "face.1983" "face.1999" "face.2011" "face.2035" "face.2055" \  
 "face.2071" "face.3236" "face.3237" "face.3047" "face.3339" "face.3054" \  
 "face.3335" "face.3230" "face.3240" "face.3061" "face.3331" "face.3224" \  
 "face.3243" "face.3068" "face.3327" "face.3218" "face.3246" "face.3075" \  
 "face.3323" "face.3212" "face.3249" "face.3082" "face.3319" "face.3206" \



"face.3252" "face.3089" "face.3315" "face.3200" "face.3255" "face.3096" \  
 "face.3311" "face.3194" "face.3258" "face.3103" "face.3307" "face.3188" \  
 "face.3261" "face.3110" "face.3303" "face.3182" "face.3264" "face.3117" \  
 "face.3299" "face.3176" "face.3267" "face.3124" "face.3295" "face.3170" \  
 "face.3270" "face.3131" "face.3291" "face.3164" "face.3273" "face.3138" \  
 "face.3287" "face.3158" "face.3276" map  
 edge delete "edge.4011" "edge.4000" "edge.4047" "edge.4379" "edge.4365" \  
 "edge.3988" "edge.3999" "edge.4059" "edge.4367" "edge.3976" "edge.3987" \  
 "edge.4081" "edge.4361" "edge.3964" "edge.3975" "edge.4083" "edge.4355" \  
 "edge.3952" "edge.3963" "edge.4095" "edge.4349" "edge.3940" "edge.3951" \  
 "edge.4107" "edge.4343" "edge.3929" "edge.3937" "edge.4117" "edge.4335" \  
 "edge.3918" "edge.3925" "edge.4129" "edge.4329" "edge.3906" "edge.3913" \  
 "edge.4141" "edge.4323" "edge.3894" "edge.3901" "edge.4153" "edge.4317" \  
 "edge.3882" "edge.3889" "edge.4179" "edge.4307" "edge.3870" "edge.3877" \  
 "edge.4177" "edge.4305" "edge.3858" "edge.3865" "edge.4189" "edge.4299" \  
 "edge.3846" "edge.3853" "edge.4201" keepsettings onlymesh  
 edge mesh "edge.4011" "edge.4000" "edge.4047" "edge.4379" "edge.4365" \  
 "edge.3988" "edge.3999" "edge.4059" "edge.4367" "edge.3976" "edge.3987" \  
 "edge.4081" "edge.4361" "edge.3964" "edge.3975" "edge.4083" "edge.4355" \  
 "edge.3952" "edge.3963" "edge.4095" "edge.4349" "edge.3940" "edge.3951" \  
 "edge.4107" "edge.4343" "edge.3929" "edge.3937" "edge.4117" "edge.4335" \  
 "edge.3918" "edge.3925" "edge.4129" "edge.4329" "edge.3906" "edge.3913" \  
 "edge.4141" "edge.4323" "edge.3894" "edge.3901" "edge.4153" "edge.4317" \  
 "edge.3882" "edge.3889" "edge.4179" "edge.4307" "edge.3870" "edge.3877" \  
 "edge.4177" "edge.4305" "edge.3858" "edge.3865" "edge.4189" "edge.4299" \  
 "edge.3846" "edge.3853" "edge.4201" successive ratio1 1 intervals 32  
 edge delete "edge.3676" "edge.2047" "edge.2067" "edge.2044" "edge.2048" \  
 "edge.2046" "edge.2045" "edge.3697" "edge.3562" "edge.2019" "edge.1996" \  
 "edge.1999" "edge.2000" "edge.1998" "edge.1997" "edge.1900" "edge.1901" \  
 "edge.1902" "edge.1903" "edge.1904" "edge.1923" "edge.1948" "edge.1949" \  
 "edge.1950" "edge.1951" "edge.1952" "edge.1971" "edge.3340" "edge.3361" \  
 "edge.3450" "edge.3473" "edge.3585" "edge.3235" "edge.1804" "edge.1805" \  
 "edge.1806" "edge.1807" "edge.1808" "edge.1827" "edge.1863" "edge.1864" \  
 "edge.1865" "edge.1866" "edge.1867" "edge.1868" "edge.3226" "edge.3123" \  
 "edge.3114" "edge.3002" "edge.1708" "edge.1709" "edge.1710" "edge.1711" \  
 "edge.1712" "edge.1731" "edge.1756" "edge.1757" "edge.1758" "edge.1759" \  
 "edge.1760" "edge.1779" "edge.2779" "edge.2893" "edge.2913" "edge.3025" \  
 "edge.1612" "edge.1613" "edge.1614" "edge.1615" "edge.1616" "edge.1635" \  
 "edge.1660" "edge.1661" "edge.1662" "edge.1663" "edge.1664" "edge.1683" \  
 "edge.2642" "edge.2651" "edge.2800" "edge.1469" "edge.1470" "edge.1471" \  
 "edge.1472" "edge.1491" "edge.1516" "edge.1517" "edge.1518" "edge.1519" \  
 "edge.1520" "edge.1539" "edge.1564" "edge.1565" "edge.1566" "edge.1567" \

"edge.1568" "edge.1587" "edge.2325" "edge.2421" "edge.2440" "edge.2533" \  
 "edge.2552" "edge.1422" "edge.1423" "edge.1424" "edge.1443" "edge.1468" \  
 "edge.2213" "edge.2204" "edge.1421" "edge.1420" "edge.2316" keepsettings onlymesh  
 edge delete "edge.1996" "edge.1997" "edge.1998" "edge.1999" "edge.2000" \  
 "edge.2019" "edge.2044" "edge.2045" "edge.2046" "edge.2047" "edge.2048" \  
 "edge.2067" "edge.3450" "edge.3562" "edge.3585" "edge.3676" "edge.3697" \  
 "edge.1708" "edge.1709" "edge.1710" "edge.1711" "edge.1712" "edge.1731" \  
 "edge.1756" "edge.1757" "edge.1758" "edge.1759" "edge.1760" "edge.1779" \  
 "edge.1804" "edge.1805" "edge.1806" "edge.1807" "edge.1808" "edge.1827" \  
 "edge.1863" "edge.1864" "edge.1865" "edge.1866" "edge.1867" "edge.1868" \  
 "edge.1900" "edge.1901" "edge.1902" "edge.1903" "edge.1904" "edge.1923" \  
 "edge.1948" "edge.1949" "edge.1950" "edge.1951" "edge.1952" "edge.1971" \  
 "edge.2893" "edge.2913" "edge.3002" "edge.3025" "edge.3114" "edge.3123" \  
 "edge.3226" "edge.3235" "edge.3340" "edge.3361" "edge.3473" "edge.1516" \  
 "edge.1517" "edge.1518" "edge.1519" "edge.1520" "edge.1539" "edge.1564" \  
 "edge.1565" "edge.1566" "edge.1567" "edge.1568" "edge.1587" "edge.1612" \  
 "edge.1613" "edge.1614" "edge.1615" "edge.1616" "edge.1635" "edge.1660" \  
 "edge.1661" "edge.1662" "edge.1663" "edge.1664" "edge.1683" "edge.2800" \  
 "edge.2779" "edge.2651" "edge.2642" "edge.2552" "edge.2533" "edge.2325" \  
 "edge.2421" "edge.2440" "edge.1420" "edge.1421" "edge.1422" "edge.1423" \  
 "edge.1424" "edge.1443" "edge.1468" "edge.1469" "edge.1470" "edge.1471" \  
 "edge.1472" "edge.1491" "edge.2204" "edge.2213" "edge.2316" keepsettings onlymesh  
 edge mesh "edge.1996" "edge.1997" "edge.1998" "edge.1999" "edge.2000" \  
 "edge.2019" "edge.2044" "edge.2045" "edge.2046" "edge.2047" "edge.2048" \  
 "edge.2067" "edge.3450" "edge.3562" "edge.3585" "edge.3676" "edge.3697" \  
 "edge.1708" "edge.1709" "edge.1710" "edge.1711" "edge.1712" "edge.1731" \  
 "edge.1756" "edge.1757" "edge.1758" "edge.1759" "edge.1760" "edge.1779" \  
 "edge.1804" "edge.1805" "edge.1806" "edge.1807" "edge.1808" "edge.1827" \  
 "edge.1863" "edge.1864" "edge.1865" "edge.1866" "edge.1867" "edge.1868" \  
 "edge.1900" "edge.1901" "edge.1902" "edge.1903" "edge.1904" "edge.1923" \  
 "edge.1948" "edge.1949" "edge.1950" "edge.1951" "edge.1952" "edge.1971" \  
 "edge.2893" "edge.2913" "edge.3002" "edge.3025" "edge.3114" "edge.3123" \  
 "edge.3226" "edge.3235" "edge.3340" "edge.3361" "edge.3473" "edge.1516" \  
 "edge.1517" "edge.1518" "edge.1519" "edge.1520" "edge.1539" "edge.1564" \  
 "edge.1565" "edge.1566" "edge.1567" "edge.1568" "edge.1587" "edge.1612" \  
 "edge.1613" "edge.1614" "edge.1615" "edge.1616" "edge.1635" "edge.1660" \  
 "edge.1661" "edge.1662" "edge.1663" "edge.1664" "edge.1683" "edge.2800" \  
 "edge.2779" "edge.2651" "edge.2642" "edge.2552" "edge.2533" "edge.2325" \  
 "edge.2421" "edge.2440" "edge.1420" "edge.1421" "edge.1422" "edge.1423" \  
 "edge.1424" "edge.1443" "edge.1468" "edge.1469" "edge.1470" "edge.1471" \  
 "edge.1472" "edge.1491" "edge.2204" "edge.2213" "edge.2316" successive \  
 ratio1 1 intervals 16



```
edge delete "edge.4908" "edge.4909" "edge.4912" "edge.4913" "edge.4917" \  
"edge.4918" "edge.4920" "edge.4921" "edge.4924" "edge.4925" "edge.4929" \  
"edge.4930" "edge.4932" "edge.4933" "edge.4936" "edge.4937" "edge.4941" \  
"edge.4942" "edge.4944" "edge.4945" "edge.4948" "edge.4949" "edge.4953" \  
"edge.4954" "edge.4957" "edge.4958" "edge.4959" "edge.4960" "edge.4965" \  
"edge.4966" "edge.4969" "edge.4970" "edge.4971" "edge.4972" "edge.4977" \  
"edge.4978" "edge.4981" "edge.4982" "edge.4983" "edge.4984" "edge.4989" \  
"edge.4990" "edge.4993" "edge.4994" "edge.4995" "edge.4996" "edge.5001" \  
"edge.5002" "edge.5005" "edge.5006" "edge.5013" "edge.5241" "edge.5247" \  
"edge.5248" "edge.5253" "edge.5254" "edge.5259" "edge.5260" "edge.5265" \  
"edge.5266" "edge.4788" "edge.4789" "edge.4792" "edge.4793" "edge.4797" \  
"edge.4798" "edge.4800" "edge.4801" "edge.4804" "edge.4805" "edge.4809" \  
"edge.4810" "edge.4812" "edge.4813" "edge.4816" "edge.4817" "edge.4821" \  
"edge.4822" "edge.4824" "edge.4825" "edge.4828" "edge.4829" "edge.4833" \  
"edge.4834" "edge.4836" "edge.4837" "edge.4840" "edge.4841" "edge.4845" \  
"edge.4846" "edge.4848" "edge.4849" "edge.4852" "edge.4853" "edge.4857" \  
"edge.4858" "edge.4860" "edge.4861" "edge.4864" "edge.4865" "edge.4869" \  
"edge.4870" "edge.4872" "edge.4873" "edge.4876" "edge.4877" "edge.4881" \  
"edge.4882" "edge.4884" "edge.4885" "edge.4888" "edge.4889" "edge.4893" \  
"edge.4894" "edge.4896" "edge.4897" "edge.4900" "edge.4901" "edge.4905" \  
"edge.4906" "edge.5242" "edge.5007" "edge.5008" "edge.5014" "edge.5017" \  
"edge.5018" "edge.5019" "edge.5020" "edge.5025" "edge.5026" "edge.5029" \  
"edge.5030" "edge.5031" "edge.5032" "edge.5037" "edge.5038" "edge.5041" \  
"edge.5042" "edge.5043" "edge.5044" "edge.5049" "edge.5050" "edge.5053" \  
"edge.5054" "edge.5055" "edge.5056" "edge.5061" "edge.5062" "edge.5065" \  
"edge.5066" "edge.5067" "edge.5068" "edge.5073" "edge.5074" "edge.5077" \  
"edge.5078" "edge.5079" "edge.5080" "edge.5085" "edge.5086" "edge.5089" \  
"edge.5090" "edge.5091" "edge.5092" "edge.5097" "edge.5098" "edge.5101" \  
"edge.5102" "edge.5103" "edge.5104" "edge.5109" "edge.5110" "edge.5113" \  
"edge.5114" "edge.5121" "edge.5187" "edge.5193" "edge.5194" "edge.5199" \  
"edge.5200" "edge.5205" "edge.5206" "edge.5211" "edge.5212" "edge.5217" \  
"edge.5218" "edge.5223" "edge.5224" "edge.5229" "edge.5230" "edge.5235" \  
"edge.5236" "edge.5115" keepsettings onlymesh  
edge mesh "edge.4908" "edge.4909" "edge.4912" "edge.4913" "edge.4917" \  
"edge.4918" "edge.4920" "edge.4921" "edge.4924" "edge.4925" "edge.4929" \  
"edge.4930" "edge.4932" "edge.4933" "edge.4936" "edge.4937" "edge.4941" \  
"edge.4942" "edge.4944" "edge.4945" "edge.4948" "edge.4949" "edge.4953" \  
"edge.4954" "edge.4957" "edge.4958" "edge.4959" "edge.4960" "edge.4965" \  
"edge.4966" "edge.4969" "edge.4970" "edge.4971" "edge.4972" "edge.4977" \  
"edge.4978" "edge.4981" "edge.4982" "edge.4983" "edge.4984" "edge.4989" \  
"edge.4990" "edge.4993" "edge.4994" "edge.4995" "edge.4996" "edge.5001" \  
"edge.5002" "edge.5005" "edge.5006" "edge.5013" "edge.5241" "edge.5247" \  
"edge.5248" "edge.5253" "edge.5254" "edge.5259" "edge.5260" "edge.5265" \  
"edge.5266" "edge.4788" "edge.4789" "edge.4792" "edge.4793" "edge.4797" \  
"edge.4798" "edge.4800" "edge.4801" "edge.4804" "edge.4805" "edge.4809" \  
"edge.4810" "edge.4812" "edge.4813" "edge.4816" "edge.4817" "edge.4821" \  
"edge.4822" "edge.4824" "edge.4825" "edge.4828" "edge.4829" "edge.4833" \  
"edge.4834" "edge.4836" "edge.4837" "edge.4840" "edge.4841" "edge.4845" \  
"edge.4846" "edge.4848" "edge.4849" "edge.4852" "edge.4853" "edge.4857" \  
"edge.4858" "edge.4860" "edge.4861" "edge.4864" "edge.4865" "edge.4869" \  
"edge.4870" "edge.4872" "edge.4873" "edge.4876" "edge.4877" "edge.4881" \  
"edge.4882" "edge.4884" "edge.4885" "edge.4888" "edge.4889" "edge.4893" \  
"edge.4894" "edge.4896" "edge.4897" "edge.4900" "edge.4901" "edge.4905" \  
"edge.4906" "edge.5242" "edge.5007" "edge.5008" "edge.5014" "edge.5017" \  
"edge.5018" "edge.5019" "edge.5020" "edge.5025" "edge.5026" "edge.5029" \  
"edge.5030" "edge.5031" "edge.5032" "edge.5037" "edge.5038" "edge.5041" \  
"edge.5042" "edge.5043" "edge.5044" "edge.5049" "edge.5050" "edge.5053" \  
"edge.5054" "edge.5055" "edge.5056" "edge.5061" "edge.5062" "edge.5065" \  
"edge.5066" "edge.5067" "edge.5068" "edge.5073" "edge.5074" "edge.5077" \  
"edge.5078" "edge.5079" "edge.5080" "edge.5085" "edge.5086" "edge.5089" \  
"edge.5090" "edge.5091" "edge.5092" "edge.5097" "edge.5098" "edge.5101" \  
"edge.5102" "edge.5103" "edge.5104" "edge.5109" "edge.5110" "edge.5113" \  
"edge.5114" "edge.5121" "edge.5187" "edge.5193" "edge.5194" "edge.5199" \  
"edge.5200" "edge.5205" "edge.5206" "edge.5211" "edge.5212" "edge.5217" \  
"edge.5218" "edge.5223" "edge.5224" "edge.5229" "edge.5230" "edge.5235" \  
"edge.5236" "edge.5115" keepsettings onlymesh
```

"edge.5248" "edge.5253" "edge.5254" "edge.5259" "edge.5260" "edge.5265" \  
 "edge.5266" "edge.4788" "edge.4789" "edge.4792" "edge.4793" "edge.4797" \  
 "edge.4798" "edge.4800" "edge.4801" "edge.4804" "edge.4805" "edge.4809" \  
 "edge.4810" "edge.4812" "edge.4813" "edge.4816" "edge.4817" "edge.4821" \  
 "edge.4822" "edge.4824" "edge.4825" "edge.4828" "edge.4829" "edge.4833" \  
 "edge.4834" "edge.4836" "edge.4837" "edge.4840" "edge.4841" "edge.4845" \  
 "edge.4846" "edge.4848" "edge.4849" "edge.4852" "edge.4853" "edge.4857" \  
 "edge.4858" "edge.4860" "edge.4861" "edge.4864" "edge.4865" "edge.4869" \  
 "edge.4870" "edge.4872" "edge.4873" "edge.4876" "edge.4877" "edge.4881" \  
 "edge.4882" "edge.4884" "edge.4885" "edge.4888" "edge.4889" "edge.4893" \  
 "edge.4894" "edge.4896" "edge.4897" "edge.4900" "edge.4901" "edge.4905" \  
 "edge.4906" "edge.5242" "edge.5007" "edge.5008" "edge.5014" "edge.5017" \  
 "edge.5018" "edge.5019" "edge.5020" "edge.5025" "edge.5026" "edge.5029" \  
 "edge.5030" "edge.5031" "edge.5032" "edge.5037" "edge.5038" "edge.5041" \  
 "edge.5042" "edge.5043" "edge.5044" "edge.5049" "edge.5050" "edge.5053" \  
 "edge.5054" "edge.5055" "edge.5056" "edge.5061" "edge.5062" "edge.5065" \  
 "edge.5066" "edge.5067" "edge.5068" "edge.5073" "edge.5074" "edge.5077" \  
 "edge.5078" "edge.5079" "edge.5080" "edge.5085" "edge.5086" "edge.5089" \  
 "edge.5090" "edge.5091" "edge.5092" "edge.5097" "edge.5098" "edge.5101" \  
 "edge.5102" "edge.5103" "edge.5104" "edge.5109" "edge.5110" "edge.5113" \  
 "edge.5114" "edge.5121" "edge.5187" "edge.5193" "edge.5194" "edge.5199" \  
 "edge.5200" "edge.5205" "edge.5206" "edge.5211" "edge.5212" "edge.5217" \  
 "edge.5218" "edge.5223" "edge.5224" "edge.5229" "edge.5230" "edge.5235" \  
 "edge.5236" "edge.5115" successive ratio1 1 intervals 24  
 volume delete "volume.320" "volume.317" "volume.290" "volume.347" \  
 "volume.287" "volume.346" "volume.291" "volume.321" "volume.316" \  
 "volume.286" "volume.345" "volume.292" "volume.322" "volume.315" \  
 "volume.285" "volume.344" "volume.293" "volume.314" "volume.323" \  
 "volume.284" "volume.343" "volume.294" "volume.313" "volume.324" \  
 "volume.283" "volume.342" "volume.295" "volume.312" "volume.325" \  
 "volume.353" "volume.341" "volume.296" "volume.311" "volume.326" \  
 "volume.281" "volume.340" "volume.297" "volume.327" "volume.310" \  
 "volume.280" "volume.298" "volume.339" "volume.309" "volume.328" \  
 "volume.279" "volume.299" "volume.338" "volume.308" "volume.329" \  
 "volume.278" "volume.337" "volume.300" "volume.307" "volume.330" \  
 "volume.277" "volume.336" "volume.301" "volume.306" "volume.331" \  
 "volume.276" "volume.335" "volume.302" "volume.305" "volume.332" \  
 "volume.357" "volume.303" "volume.334" "volume.304" "volume.333" \  
 "volume.274" "volume.13" "volume.43" "volume.89" "volume.14" "volume.91" \  
 "volume.44" "volume.93" "volume.15" "volume.45" "volume.95" "volume.16" \  
 "volume.46" "volume.97" "volume.139" "volume.17" "volume.218" "volume.138" \  
 "volume.222" "volume.214" "volume.216" "volume.136" "volume.134"

"volume.206" "volume.208" "volume.200" "volume.196" "volume.132" \  
"volume.188" "volume.186" "volume.130" "volume.180" "volume.184" \  
"volume.128" "volume.174" "volume.265" "volume.126" "volume.168" \  
"volume.166" "volume.124" "volume.158" "volume.164" "volume.122" \  
"volume.416" "volume.389" "volume.359" "volume.419" "volume.386" \  
"volume.385" "volume.420" "volume.390" "volume.415" "volume.360" \  
"volume.384" "volume.421" "volume.391" "volume.414" "volume.361" \  
"volume.383" "volume.422" "volume.392" "volume.413" "volume.362" \  
"volume.382" "volume.423" "volume.393" "volume.412" "volume.363" \  
"volume.381" "volume.424" "volume.394" "volume.411" "volume.364" \  
"volume.380" "volume.425" "volume.395" "volume.410" "volume.365" \  
"volume.379" "volume.426" "volume.396" "volume.409" "volume.366" \  
"volume.378" "volume.427" "volume.397" "volume.408" "volume.367" \  
"volume.377" "volume.428" "volume.398" "volume.407" "volume.368" \  
"volume.376" "volume.429" "volume.399" "volume.406" "volume.369" \  
"volume.375" "volume.430" "volume.400" "volume.405" "volume.370" \  
"volume.374" "volume.431" "volume.401" "volume.404" "volume.371" \  
"volume.373" "volume.432" "volume.403" "volume.402" "volume.372" onlimesh  
volume mesh "volume.320" "volume.317" "volume.290" "volume.347" "volume.287" \  
"volume.346" "volume.291" "volume.321" "volume.316" "volume.286" \  
"volume.345" "volume.292" "volume.322" "volume.315" "volume.285" \  
"volume.344" "volume.293" "volume.314" "volume.323" "volume.284" \  
"volume.343" "volume.294" "volume.313" "volume.324" "volume.283" \  
"volume.342" "volume.295" "volume.312" "volume.325" "volume.353" \  
"volume.341" "volume.296" "volume.311" "volume.326" "volume.281" \  
"volume.340" "volume.297" "volume.327" "volume.310" "volume.280" \  
"volume.298" "volume.339" "volume.309" "volume.328" "volume.279" \  
"volume.299" "volume.338" "volume.308" "volume.329" "volume.278" \  
"volume.337" "volume.300" "volume.307" "volume.330" "volume.277" \  
"volume.336" "volume.301" "volume.306" "volume.331" "volume.276" \  
"volume.335" "volume.302" "volume.305" "volume.332" "volume.357" \  
"volume.303" "volume.334" "volume.304" "volume.333" "volume.274" \  
"volume.13" "volume.43" "volume.89" "volume.14" "volume.91" "volume.44" \  
"volume.93" "volume.15" "volume.45" "volume.95" "volume.16" "volume.46" \  
"volume.97" "volume.139" "volume.17" "volume.218" "volume.138" "volume.222" \  
"volume.214" "volume.216" "volume.136" "volume.134" "volume.206" \  
"volume.208" "volume.200" "volume.196" "volume.132" "volume.188" \  
"volume.186" "volume.130" "volume.180" "volume.184" "volume.128" \  
"volume.174" "volume.265" "volume.126" "volume.168" "volume.166" \  
"volume.124" "volume.158" "volume.164" "volume.122" "volume.416" \  
"volume.389" "volume.359" "volume.419" "volume.386" "volume.385" \  
"volume.420" "volume.390" "volume.415" "volume.360" "volume.384" \

```

"volume.421" "volume.391" "volume.414" "volume.361" "volume.383" \
"volume.422" "volume.392" "volume.413" "volume.362" "volume.382" \
"volume.423" "volume.393" "volume.412" "volume.363" "volume.381" \
"volume.424" "volume.394" "volume.411" "volume.364" "volume.380" \
"volume.425" "volume.395" "volume.410" "volume.365" "volume.379" \
"volume.426" "volume.396" "volume.409" "volume.366" "volume.378" \
"volume.427" "volume.397" "volume.408" "volume.367" "volume.377" \
"volume.428" "volume.398" "volume.407" "volume.368" "volume.376" \
"volume.429" "volume.399" "volume.406" "volume.369" "volume.375" \
"volume.430" "volume.400" "volume.405" "volume.370" "volume.374" \
"volume.431" "volume.401" "volume.404" "volume.371" "volume.373" \
"volume.432" "volume.403" "volume.402" "volume.372" "volume.418" \
"volume.348" "volume.289" "volume.334" "volume.416" map
blayer create first 0.003 growth 1.4 total 0.0489715 rows 6 transition 1 \
trows 0 uniform
window modify invisible mesh
blayer create first 0.003 growth 1.4 total 0.0489715 rows 6 transition 3 \
trows 1 uniform
blayer attach "b_layer.9" face "face.3370" "face.3370" "face.3370" \
"face.3370" "face.3370" "face.3370" "face.3370" "face.3370" \
"face.3370" "face.3370" "face.3370" "face.3370" "face.3370" \
"face.2932" "face.2932" "face.2932" "face.2932" \
"face.2932" "face.2932" "face.2932" "face.2932" "face.2932" "face.2932" \
"face.2932" "face.2932" "face.2932" "face.2932" "face.2932" \
"face.3370" edge "edge.4763" "edge.4726" "edge.4701" "edge.4714" \
"edge.4659" "edge.4621" "edge.4612" "edge.4593" "edge.4532" "edge.4520" \
"edge.4515" "edge.4774" "edge.4469" "edge.4404" \
"edge.4767" "edge.4715" "edge.4683" "edge.4693" "edge.4663" \
"edge.4637" "edge.4582" "edge.4561" "edge.4521" "edge.4503" "edge.4494" \
"edge.4439" "edge.4418" "edge.4428" "edge.4405" "edge.4770" add
blayer create first 0.003 growth 1.4 total 0.0489715 rows 6 transition 3 \
trows 1 uniform
blayer attach "b_layer.10" face "face.3373" \
"face.3373" "face.3373" "face.3373" "face.3373" "face.3373" "face.3373" \
"face.3373" "face.3373" "face.3373" "face.3373" "face.3373" "face.3373" \
"face.3373" "face.3373" "face.3351" "face.3351" \
"face.3351" "face.3351" "face.3351" "face.3351" "face.3351" "face.3351" \
"face.3351" "face.3351" "face.3351" "face.3351" "face.3351" "face.3351" \
"face.3351" edge "edge.3678" "edge.3612" \
"edge.3500" "edge.3342" "edge.3306" "edge.3151" "edge.3052" "edge.2894" \
"edge.2858" "edge.2705" "edge.2534" "edge.2422" "edge.2379" "edge.2241" \
"edge.2170" "edge.2115" "edge.2285" "edge.3795" \

```

```

"edge.2499" "edge.2611" "edge.2748" "edge.2789" "edge.2943" "edge.3013" \
"edge.3196" "edge.3269" "edge.3419" "edge.3461" "edge.3573" "edge.3727" add
blayer create first 0.003 growth 1.4 total 0.0489715 rows 6 transition 1 \
trows 0 uniform
blayer attach "b_layer.11" volume "volume.12" "volume.12" "volume.269" \
"volume.269" "volume.273" "volume.273" "volume.433" "volume.435" \
"volume.438" "volume.437" "volume.433" "volume.435" "volume.438" \
"volume.437" face "face.2111" "face.138" "face.2110" "face.2119" \
"face.2116" "face.2115" "face.2935" "face.3354" "face.3376" "face.3383" \
"face.3357" "face.3358" "face.3374" "face.3379" add
blayer attach "b_layer.11" face "face.3372" edge "edge.5377" add
edge delete "edge.5374" "edge.5305" "edge.5377" "edge.5302" keepsettings onlymesh
edge mesh "edge.5374" "edge.5305" "edge.5377" "edge.5302" successive ratio1 1 \
intervals 15
edge delete "edge.5371" "edge.5301" "edge.5370" "edge.5300" keepsettings onlymesh
edge modify "edge.5301" "edge.5370" backward
edge mesh "edge.5371" "edge.5301" "edge.5370" "edge.5300" successive ratio1 1 \
intervals 9
edge delete "edge.5309" "edge.5379" "edge.5308" "edge.5378" keepsettings onlymesh
edge modify "edge.5379" "edge.5308" backward
edge mesh "edge.5309" "edge.5379" "edge.5308" "edge.5378" successive ratio1 1 \
intervals 7
face mesh "face.2932" "face.3370" "face.3373" "face.3351" map
volume mesh "volume.436" cooper source "face.2932" "face.3373"
volume mesh "volume.270" cooper source "face.3370" "face.3351"
/redraw geometry to mesh
face cmove "face.3045" "face.3340" multiple 1 dangle 180 vector 0 0 2 origin \
1.1586149 -1.77165 -0.85
face cmove "face.3045" "face.3340" multiple 1 dangle 180 vector 0 0 2 origin \
1.5704519 -1.77165 -0.85
face cmove "face.3386" "face.3387" "face.3045" multiple 1 dangle 180 vector 0 \
0 2 origin 1.9822889 -1.77165 -0.85
face cmove "face.3384" "face.3385" "face.3340" "face.3045" "face.3386" \
"face.3387" multiple 1 dangle 180 vector 0 0 2 origin 0.74677788 -1.77165 \
-0.85
face unite faces "face.3385" "face.3384" "face.3391" "face.3392" "face.3393" \
"face.3394" "face.3395" "face.3396" real
face unite faces "face.3386" "face.3387" "face.3389" "face.3388" "face.3390" \
real
face cmove "face.3385" multiple 1 dangle 90 vector 0 0 2 origin 1.1586149 \
-1.77165 -0.85
face cmove "face.3386" multiple 1 dangle 90 vector 0 0 -2 origin 1.5704519 \

```

```

-1.77165 1.15
face cmove "face.3144" "face.3285" multiple 1 dangle 180 vector 0 0 2 origin \
1.1586149 1.77165 -0.85
face cmove "face.3144" "face.3390" "face.3389" "face.3285" multiple 1 dangle \
180 vector 0 0 2 origin 1.5704519 1.77165 -0.85
face cmove "face.3393" multiple 1 dangle 180 vector 0 0 2 origin 2.3941259 \
1.77165 -0.85
face cmove "face.3389" "face.3390" "face.3285" "face.3144" "face.3391" \
"face.3394" multiple 1 dangle 180 vector 0 0 2 origin 0.74677788 1.77165 \
-0.85
face unite faces "face.3391" "face.3392" "face.3394" "face.3393" "face.3395" \
real
face unite faces "face.3401" "face.3400" "face.3399" "face.3398" "face.3397" \
"face.3396" "face.3389" real
face unite faces "face.3401" "face.3390" real
face cmove "face.3401" multiple 1 dangle 90 vector 0 0 -2 origin 1.1586149 \
1.77165 1.15
face cmove "face.3391" multiple 1 dangle 90 vector 0 0 2 origin 1.5704519 \
1.77165 -0.85
volume split "volume.118" faces "face.3386" "face.3388" "face.3387" \
"face.3385" "face.3401" "face.3402" "face.3403" "face.3391" connected

```

## REFERENCES

- Bohl, J.G.V. (1940). Behavior of Parallel Air Streams. *Ingenieur Archiv*, Vol. 11, pp 295.
- Bons, J. P., MacArthur, C. D., & Rivir, R. B. (1994). The Effect of High Freestream Turbulence on Film Cooling Effectiveness. *ASME J.Turbomach.*, 118, pp. 814-825.
- Bunker, R. S. (2005). A Review of Shaped Holes Turbine Film Cooling Technology. *ASME J. Heat Transfer*, 127, pp. 441–453.
- Bunker, R. S., Bailay, J.C., Lee, C.P., & Abuaf, N. (2001). Method for Improving the Cooling Effectiveness of a Gaseous Coolant Stream, and related Articles of Manufacturer. *US Patent*, 6,234,755.
- Burd, S. W., Kaszeta, R. W., & Simon, T. W. (1998). Measurements in Film Cooling Flows: Hole L/D and Turbulence Intensity Effects. *ASME J. Turbomach.*, 120, pp. 791–798.
- Celik, I.B. (2003). *Procedure for Estimation and Reporting of Discretization Error in CFD Application*. West Virginia University.
- Dorrington, J.R. & Bogard, D.G. (2007). Film Effectiveness Performance for Coolant Holes Embedded in Various Shallow Trench and Crater Depressions. *ASME paper*, GT-2007-27992.
- Ekkad, S. V., Mehendale, A. B., Han, J. C., & Lee, C. P. (1997). Combined Effect of Grid Turbulence and Unsteady Wake on Film Effectiveness and Heat Transfer

- Coefficients of a Gas Turbine Blade With Air and CO<sub>2</sub> Film Injection. *ASME J. Turbomach.*, 119, pp. 594–600.
- Eriksen, V. L., & Goldstein, R. J. (1974). Heat Transfer and Film Cooling Following Injection through Inclined Circular Tubes. *ASME Journal Heat Transfer*, 96, pp. 239-245.
- Fluent. (2009). *Fluent Version 6.3.26*. USA, ANSYS Inc.
- Fluent. (2010). *Fluent Version 12.1*. USA, ANSYS Inc.
- Friedrich, S. (1991). Endwall Film-Cooling in Axial Flow Turbines. *Ph.D. Dissertation*.
- Funazaki, K., Yokota, M., & Yamawaki, S. (1997). Effect of Periodic Wake Passing on Film Cooling Effectiveness of Discrete Cooling Holes Around the Leading Edge of a Blunt Body. *ASME J. Turbomach.*, 119, pp. 292–301.
- Funazaki, K., Koyabu, E., & Yamawaki, S. (1998). Effect of Periodic Wake Passing on Film Effectiveness of Inclined Discrete Cooling Holes around the Leading Edge of a Blunt Body. *Journal of Heat Transfer*, Vol. 120, pp 70.
- Gambit. (2009). *Gambit Version 2.3.16*. USA, ANSYS Inc.
- Goldstein, R.J., Eckert, E.R.G., & Ramsey, J.W. (1968). Film Cooling with Injection Through Holes: Adiabatic Wall Temperatures Downstream of a Circular Hole. Paper No. 68-GT-19, *Gas Turbine Conference*, Washington, D.C., USA.
- Goldstein, R.J., et al. (1970). Film Cooling Following Injection Through Inclined Circular Tubes. *Israel Journal of Technology*. 108(1-2): p. 145-154.
- Gregg, S. (2010). *Private Communication*. Pratt and Whitney. Mentor, Connecticut.



- Han, J.C., Zhang, L., & Ou, S. (1993). Influence of Unsteady Wake on Heat Transfer Coefficient From a Gas Turbine Blade. *Journal of Heat Transfer*, Vol. 115, pp 904.
- Harrison, K.L. & Bogard, D.G. (2007). CFD Predictions of Film Cooling Adiabatic Effectiveness for Cylindrical Holes Embedded in Narrow and Wide Traverse Trenches. *IGTI Turbo Expo*, Montreal, 2007, Paper No. GT-2007-28005.
- Harrison, S. (1989). The Influence of Blade Stacking on Turbine Losses. *Ph.D. Thesis*.
- Heidmann, J.D., Lucci, B.L., & Reshotko, E. (2001). An experimental Study of the Effect of Wake Passing on Turbine Blade Film Cooling. *ASME J. Turbo mach*, 123, pp. 214.
- Javadi, K. & Javadi, A. (2008). Introducing Film Cooling Uniformity Coefficient (CUC). *ASME International Mechanical Engineering Congress and Exposition*, Boston, Massachusetts, Paper No. IMECE 2008-68502.
- Kapat, J.S. (2009). *Private Communication*. University of Central Florida, Orlando, Florida.
- Kercher, D.M. (2003). *Film-Cooling Bibliography 1940-2002*.
- Kohli, A., & Bogard, D. G. (1998). Effects of Very High Free-Stream Turbulence on the Jet-Mainstream Interaction in a Film Cooling Flow. *ASME J. Turbomach.*, 120, pp. 785-790.

- Kost, F.& Nicklas, M. (2001). Film-Cooled Turbine Endwall in a Transonic Flow Field: Part I—Aerodynamic Measurements. *Journal of Turbomachinery*, Vol. 123, pp. 709-720.
- Liu Q. (2006). Study of Heat Transfer Characteristics of Impinging Air Jet Using Pressure and Temperature Sensitive Luminescent Paint. *Ph.D. Dissertation*, Orlando, UCF.
- Nguyen, C.Q., Rodriguez, S., Zuniga, H.A., Ho, S.H. & Kapat, J.S. (2009). Sensitivity Analysis of Flow Conditions and Geometric Parameters on the Film Cooling Effectiveness for a Flat Test Plate, Part 1: Single Row of Cylindrical Holes Film Cooling. *ASME Proceedings of Summer Heat Transfer*, San Francisco, California, USA Paper HT-88141.
- Nguyen, C.Q., Tran, N.T.V., Bernier, B.C., Ho, S.H., & Kapat, J. S. (2010). Sensitivity Analysis for Film Effectiveness on a Round Film Hole Embedded in a Trench Using Conjugate Heat Transfer Numerical Model. *ASME Proceedings of Turbo Expo*, Glasgow, UK, 2009, Paper GT2010-22120.
- Nguyen, C. Q. (2010). Interaction Between Secondary Flow & Film Cooling Jets of a Realistic Annular Airfoil Cascade (High Mach Number). *Ph.D. Dissertation*, University of Central Florida, Orlando, FL.
- Qiu, Junfen. (2001) Temperature Sensitive Paint Development for Thermo graphic Applications. *MS Thesis*, University of Central Florida, Orlando, FL.

- Rodriguez, S. (2008). Effect of Pressure Gradient and Wake on Endwall Film Cooling Effectiveness. *Ph.D. Dissertation*, University of Central Florida, Orlando, Florida.
- Sauer, H., Müller, R., & Vogeler, K. (2001). Reduction of Secondary Flow Losses in Turbine Cascades by Leading Edge Modifications at the Endwall. *J. of Turbomachinery*, Vol. 123, pp. 207-213.
- Sawyer. (1966). *Gas Turbine Engineering Handbook*. 1st Edition, Stamford, CT, Gas Turbine Publications, Inc.
- Sinha, A. K., Bogard, D. G., & Crawford, M. E. (1991). Film Cooling Effectiveness Downstream of a Single Row of Holes with Variable Density Ratio. *ASME J. Turbomachinery*, 113, pp. 442-449.
- Sultanian, B. K. (2009). *EML – Turbomachinery. Lecture Slides*, University of Central Florida, Mechanical, Materials, and Aerospace Engineering, Orlando, FL.
- Taslim, M.E. & Ugarte, S. (2004). Discharge Coefficient Measurements for Flow through Compound-Angle Conical Holes with Cross-Flow. *International Journal of Rotating Machinery*, 10, pp. 145-153.
- Varadarajan, K., & Bodard, D. (2004). Effects of Hot Streaks on Adiabatic Effectiveness for a Film Cooled Turbine Vane. *ASME paper No. GT2004-54016*.
- Waye, S. K., & Bogard, D.G. (2006). High Resolution Film Cooling Effectiveness Measurements of Axial Holes Embedded in a Transverse Trench with Various

Trench Configurations. *IGTI Turbo Expo*, Paper No. GT-2006-90226, Barcelona, Spain.

Womack, K. M., Volino, R. J., & Schultz, M. P. (2008). Measurements in Film Cooling Flows with Periodic Wakes. *Journal of Turbomachinery*, Vol. 130, pp. 1-13.

Zuniga, H. A. (2007). Study of Discharged Coefficient and Trends in Film Cooling Effectiveness of Conical Holes with Increasing Diffusion Angles. *MS Thesis*.